



VIVAX
METROTECH

vScan User Handbook (English Edition)

Version 1.3

P/N: 4.04.000051



Table of Content

- Introduction.....1
- 1.1 General Safety & Care Information.....1
 - 1.1.1 Work-site Safety.....1
 - 1.1.2 Equipment Safety.....1
 - 1.1.3 Batteries and Environmental Safety1
 - 1.1.3.1 Alkaline Batteries (non-rechargeable).....1
 - 1.1.3.2 Nickel Metal Hydride Batteries (rechargeable).....2
 - 1.1.3.3 Lithium-ion Batteries (rechargeable).....2
 - 1.1.3.4 Lithium-metal Batteries (non-rechargeable).....2
 - 1.1.3.5 Transportation of Lithium-ion and Lithium-metal Batteries.....2
 - 1.1.3.6 General Rules Regarding Disposal of Batteries.....3
 - 1.1.4 Care of Equipment.....3
 - 1.1.5 Care When Interpreting the Information Provided by the Locator.....3
 - 1.1.6 American & Canadian Safety Notices.....4
- 1.2 Service & Support.....5
 - 1.2.1 Serial Number and Software Revision Number.....5
 - 1.2.2 Distributors and Service Centers Closest to You:.....6
- Power Supplies.....7
 - 2.1 vScan Receiver Batteries.....7
 - 2.1.1 Alkaline Batteries.....7
 - 2.1.2 Charging the Receiver Optional Lithium-ion Battery Pack.....7
 - 2.2 vScan Transmitter Batteries.....8
 - 2.2.1 Alkaline Batteries.....8
 - 2.2.2 Charging the Transmitter Lithium-ion Batteries.....8
- User Controls/Connections.....10
 - 3.1 Receiver.....10
 - 3.1.1 Display.....10
 - 3.1.2 Receiver Controls.....10
 - 3.1.3 Warnings/Alerts.....11
 - 3.1.3.1 Shallow Line Alert.....11
 - 3.1.3.2 Swing Alert.....12
 - 3.1.3.3 Signal Overload Alert.....12
 - 3.1.3.4 Overhead Signal Alert.....12
 - 3.1.3.5 Action Required Alert.....12
 - 3.2 Transmitter.....13
- Locating.....14
 - 4.1 Switching the vScan Locator On and Off.....14
 - 4.2 Passive Locating.....14
 - 4.2.1 Detecting Radio Signals.....15
 - 4.2.2 Detecting Power Signals.....17
 - 4.3 Active Locating.....17
 - 4.3.1 Direct Connection.....17
 - 4.3.2 Signal Clamp.....19



4.3.3	Induction (33 kHz).....	20
4.3.4	Detecting Active Signals.....	21
4.4	Taking Depth and Current Measurements.....	22
4.4.1	Depth in power mode.....	22
4.4.2	Checking for depth errors due to signal distortion.....	22
4.5	When to use 33 kHz, 131 kHz or Dual(131 kHz + 33 kHz) Mode.....	23
4.6	Metal Locate Mode (vScanM Cover Detector).....	23
4.6.1	Locating a Buried Cover.....	23
4.7	Locating Non-metallic Pipes or Ducts.....	24
4.8	Advanced Locating Techniques.....	26
4.8.1	Two Person Sweep.....	26
4.8.2	“Swamping” an area with Signal (broad induction).....	26
4.8.3	Nulling Out a Signal (Induction Mode).....	28
4.8.4	Capacitive Coupling.....	29
4.9	Self-Test/Calibration Check.....	29
4.9.1	The vScan Receiver.....	29
4.9.2	vScan Transmitter Check.....	30
4.10	GPS.....	31
4.11	Using an External GPS.....	32
4.12	Creating “Points of Interest” (POI).....	33
4.13	Bluetooth.....	33
4.14	MyvScan.....	35
4.14.1	Using MyvScan.....	36
4.14.2	Navigating around MyvScan.....	37
	Glossary.....	39



Introduction

This section provides general information for all Vivax-Metrotech instruments regarding safety and battery related information.

1.1 General Safety & Care Information

- People suitably trained in the use of pipe and cable locators should only use this equipment.

1.1.1 Work-site Safety



WARNING

- Always comply with your company's work practices and safety codes.
- Always comply with local, state, federal or national applicable work practices and safety codes.
- Unless having the required authorization, license and appropriate training – **do not** make connections to any pipe, cable or conductor.
- Unless otherwise stated on the product labeling and in the products user handbook, this product is not "intrinsically safe" and should not be used in areas requiring "intrinsically safe" approvals.
- The equipment should not come in contact with corrosive or hazardous chemicals, gases or dust.
- **Do not** directly connect this equipment to cables or pipes that have a potential difference to ground of greater than 25V AC.
- **Always remember to dig safely.**

1.1.2 Equipment Safety



WARNING

- **Do not** open the enclosures (housings) of either the transmitter or receiver.
- Place the ground stake firmly in the ground before connecting the cable from the transmitter.

1.1.3 Batteries and Environmental Safety

Vivax-Metrotech products use four types of batteries:

- Alkaline batteries – non-rechargeable
- Nickel metal hydride batteries – rechargeable
- Lithium-ion batteries – rechargeable
- Lithium-metal batteries – (small non-rechargeable button cells for "clock" applications)

1.1.3.1 Alkaline Batteries (non-rechargeable)



WARNING

- When replacing the alkaline batteries – use only the size and type specified – **do not** mix battery types (rechargeable and alkaline).
- **Do not** mix partially discharged and fully charged cells in the same battery pack – **do not** mix old with new.
- **Never** attempt to charge alkaline batteries.

1.1.3.2 Nickel Metal Hydride Batteries (rechargeable)



WARNING

- When using rechargeable batteries, use only the correct charging device supplied or specified by the manufacturer. The battery pack or the battery charger will contain circuitry to manage the charging process – other chargers, even if they have the same connector, polarity, voltage & current rating, will not have the same control circuitry and can cause damage to the product, overheating, and in extreme cases fire or harm to the individual.
- **Do not** assume that if the plug fits it is the correct charger – a charger with the correct part number **must** be used – just because it is a Vivax-Metrotech charger **does not** mean it is the correct charger.
- Before using for the first time, charge rechargeable batteries for six hours. If at any time the rechargeable batteries **do not** last as long as anticipated – discharge fully and then charge for six hours.
- Care should be taken when charging batteries – **never** repeatedly recharge batteries (or turn power off & on) without using the instrument. If used with an inverter in a vehicle, charge the product then unplug the charger and **do not** charge again until the rechargeable batteries have been used for at least 10 minutes. Failure to do this could result in the overcharging of the battery which will shorten the life of the battery, and could in some circumstances cause overheating or fire.
- If ever the product becomes hot during the charging process **immediately** unplug the charger and use the rechargeable batteries for at least 10 minutes before recharging. If this reoccurs the next time the unit is charged, return immediately to Vivax-Metrotech for repair.
- **Do not** charge batteries for prolonged periods of time. Charging for prolonged period of time could overcharge the battery, reduce the battery life and in extreme circumstances cause damage to the locator or start the locator on fire.

1.1.3.3 Lithium-ion Batteries (rechargeable)



WARNING

- Lithium-ion batteries – some products use Lithium-ion batteries.
- These are custom made battery packs and should not be dismantled or damaged.

1.1.3.4 Lithium-metal Batteries (non-rechargeable)



WARNING

- Commonly known as “button cells” these are small, non-rechargeable batteries used to power internal “clocks” within some units (similar to computers). Generally, they have a life of three-five years.
- Under no circumstances should any attempt be made to charge these batteries.

1.1.3.5 Transportation of Lithium-ion and Lithium-metal Batteries



WARNING

- The Lithium-ion and Lithium-metal batteries used in Vivax-Metrotech products meet the required safety standards and include the designated protection circuitry.
- When batteries with Lithium-ion and Lithium-metal batteries are transported, or products containing Lithium-ion batteries, the packaging **must** include specified warning labels and shipping documentation containing the appropriate information. **Please contact Vivax-Metrotech Customer Service (USA 1-800-446-3392, International +1-408-734-1400 (USA Pacific Time Zone)) for more details.**
- Regulations require specific labelling requirements for the shipping of products containing Lithium-ion batteries and spare

battery packs (battery packs that are not inside a product). There are also standards for the packaging and limitations on the weight of the package, and the packaging must be marked with the appropriate warning labels. **Please contact Vivax-Metrotech Customer Service (USA 1-800-446-3392, International +1-408-734-1400 (USA Pacific Time Zone)) for more details.**

- Vivax-Metrotech vScan products using Lithium-ion batteries are classified as "not restricted", they can be shipped normally by road/rail/sea & air (passenger & freight aircraft) without restrictions. If at any point Vivax-Metrotech manufactures a product containing batteries that would fall under "hazardous cargo" restrictions it will be clearly noted on the product labeling and in the user handbook.

1.1.3.6 General Rules Regarding Disposal of Batteries



WARNING

- **Never** disassemble a battery, or battery pack.
- **Never** dispose of in a fire or water.
- Dispose of batteries in accordance with your company's work practice and any local, state, federal or national standards or recognized best practice. Always dispose of batteries responsibly.



IMPORTANT

Remember - Batteries contain dangerous chemicals – They can be affected by water ingress or excessive heat; they can explode or catch fire. They can also cause electric shocks.

1.1.4 Care of Equipment

- Use equipment only as directed in this user handbook.
- **Do not** immerse any part of this equipment in water.
- Store in a dry place.
- Keep equipment in the case provided when not in use.
- If left for prolonged period of time, remove alkaline batteries.
- Keep unit clean and free of dust and dirt.
- Protect against excessive heat.

1.1.5 Care When Interpreting the Information Provided by the Locator



WARNING

- Like all locators – this instrument is locating, and providing depth and current readings based on electromagnetic signals that radiate from the buried cable or pipe. In most cases these signals will enable the locator to pinpoint both position depth and current correctly.
- **Beware** – in some cases other factors will distort electromagnetic fields radiating from the cable or pipe being located, resulting in incorrect information.
- Always locate responsibly, and use information learned during your training to interpret the information provided by the locator.
- **Do not** provide information regarding depth of cable or pipe to anyone unless authorized to do so by your company.
- **Remember** that depth measurements are to the center of the electromagnetic field or pipe – in the case of pipes this may be significantly deeper than the top of the pipe.

1 Introduction

1.1.6 American & Canadian Safety Notices

USA

- This transmitter and receiver comply with the general conditions of operation, pursuant to part 15 of the FCC Rules.
 - CFR 47 Part 15
- Changes or modifications not expressly approved by the manufacturer could void the user's authority to operate the products.

CANADA

- Equipment is for use by trained operators only, and not for general household or consumer use.
- Operation is subject to the following two conditions: (1) this device may not cause interference, and (2) this device must accept any interference that may cause undesired operation of the device.

EUROPE

- Vivax-Metrotech confirms that the location system is compliant with relevant provision of European directive 1999/5/EC and the low voltage directive 2006/95/EC.
 - EN 55011
 - EN 61000-4-2: A1 & A2
 - EN 61000-4-3
 - EN 61000-4-8: A1
 - EN 61000-6-2
 - EN 61000-6-3
 - EN 61010-1
 - EN 61010-2-031
 - EN 61010-2-032
 - ETSI EN 300 330-2
 - ETSI EN 301 489-1
 - ETSI EN 301 489-3

1.2 Service & Support

1.2.1 Serial Number and Software Revision Number

Always quote your receiver and transmitter model number, serial number and software revision number when requesting product support. They can be found as follows: (for reference only)



1	Model & Serial Number
---	-----------------------

NOTE

The transmitter model & serial number can be found at the bottom of the transmitter and also inside the transmitter between the battery tray and the main module of transmitter.



Software Revision Number: For the receiver, the software revision number is displayed on the LCD during the startup sequence or can be found in the "About" section of the user menu. This also applies to transmitters with displays. The user cannot identify the software revision for transmitters without displays.

1.2.2 Distributors and Service Centers Closest to You:

Worldwide Sales Offices and Service Centers	
World Headquarters, United State of America	Central/South America and the Caribbean
<p>Vivax-Metrotech Corporation 3251 Olcott Street, Santa Clara, CA 95054, USA Website : www.vivax-metrotech.com</p> <p>Sales & Sales Support: T/Free : 800-446-3392 Tel : +1-408-734-1400 Fax : +1-408-734-1415 Email : sales@vxmt.com</p> <p>Service & Repairs: T/Free : 800-638-7682 Tel : +1-408-962-9990 Fax : +1-408-734-1799 Email : service@vxmt.com</p>	<p>Ventas para América Latina 3251 Olcott Street, Santa Clara, CA 95054, USA</p> <p>T/Free : 800-446-3392 Tel : +1-408-734-1400 Fax : +1-408-743-5597 Website : www.vivax-metrotech.com Email : VentasparaAmericaLatina@vxmt.com</p>
	France
	<p>Vivax-Metrotech SAS Technoparc - 1 allée du Moulin Berger, 69130 Ecully, France</p> <p>Tel : +33(0)4 72 53 03 03 Fax : +33(0)4 72 53 03 13 Website : www.vivax-metrotech.com Email : salesfrance@vxmt.com</p>
Canada	
<p>Vivax Canada Inc. 41 Courtland Ave Unit 6, Vaughan, ON L4K 3T3, Canada</p> <p>Tel : +1-289-846-3010 Fax : +1-905-752-0214 Website : www.vivax-metrotech.com Email : CanadianSales@vxmt.com</p>	
Germany	
<p>Metrotech Vertriebs GmbH Am steinernen Kreuz 10a D-96110 Schesslitz</p> <p>Tel : +49 954 277 227 43 Email : salesEU@vxmt.com</p>	
	United Kingdom
	<p>Vivax-Metrotech Ltd. Unit 1, B/C Polden Business Centre, Bristol Road, Bridgwater, Somerset, TA6 4AW, UK</p> <p>Tel : +44(0)1793 822679 Website : www.vivax-metrotech.com Email : salesUK@vxmt.com</p>
International Distributors and Service Centers	
Australasia	China
<p>Vivax-Metrotech AUS Unit 1, 176 South Creek Road, Cromer NSW 2099, Australia</p> <p>Tel : +61-2-9972-9244 Fax : +61-2-9972-9433 Website : www.vivax-metrotech.com Email : sales@vxmtaus.com service@vxmtaus.com</p>	<p>Leidi Utility Supply (Shanghai) Ltd. No. 780, Tianshan Rd, Shanghai, China 200051</p> <p>T/Free : 4008-206-719 Tel : +86-21-5235-3001 Fax : +86-21-5235-8365 Website : www.leidi.cn Email : info@leidi.cn</p>

Power Supplies



WARNING

Read the section 1.1, General Safety & Care information, of this document to learn more on the safe use, charging, handling/ shipping and disposal of batteries.

The vScan is supplied as standard with alkaline battery packs. Both the transmitter and receiver can be supplied with optional Lithium-ion rechargeable batteries.

2.1 vScan Receiver Batteries

2.1.1 Alkaline Batteries

The vScan requires six AA type alkaline batteries. To replace the batteries, unscrew the ¼ turn fastener of the battery compartment and open the internal battery door. Remove the battery holder and replace **all** the batteries. Mixing good and discharged batteries may result in excessive heat or even fire.



2.1.2 Charging the Receiver Optional Lithium-ion Battery Pack



The battery can be charged in situ. Unscrew the ¼ turn fastener of the battery compartment (do not open the internal battery door). Align the red dot on the charger plug with the dot on the charging socket and connect together. Connect the supplied charger to the mains and switch on. The charging LED on the charger will illuminate red until the batteries are charged. The LED will then turn green indicating a full charge.



NOTE

Do not insert rechargeable batteries in the dry cell (alkaline battery) holder. Only use the rechargeable battery pack supplied by Vivax-Metrotech.

2.2 vScan Transmitter Batteries

Low battery condition is indicated by the following:

- Very slow pulsing from the sounder (Short pulse every 1.5 seconds).
- The active LED pulses in the same way as sounder.
- Transmitted signal has slow pulse, in the same way as the sounder. (This informs the vScan receiver operator that the transmitter batteries have a low charge.)

2.2.1 Alkaline Batteries

The vScan transmitter requires four D type alkaline batteries. To replace the batteries, unscrew the two retaining fasteners of the battery compartment. Remove the old batteries and replace all of them. Mixing good and discharged batteries may result in excessive heat or even fire.

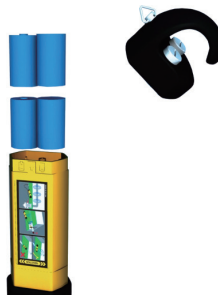

2.2.2 Charging the Transmitter Lithium-ion Batteries



Remove the battery pack by unscrewing the two fasteners of the battery compartment. Align the red dot on the charger with the dot on the charging socket, situated at the base of the battery, and connect together. Connect the charger to the mains and switch on. The charging LED on the charger will illuminate red until the batteries are charged. The LED will then turn green indicating a full charge.

2 Power Supplies

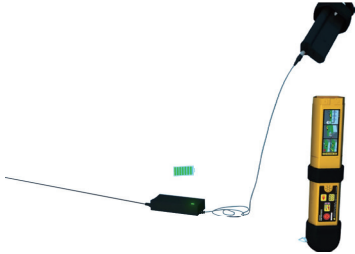

WARNING
Only use the charger supplied. Using any non-recommended chargers may result in damage to the equipment and possibly a fire or explosion.

User Controls/Connections

3.1 Receiver

3.1.1 Display

The display has a dot matrix format. The contents of the screen are dependent on the function being performed. Details of these screens are revealed further in the user handbook.

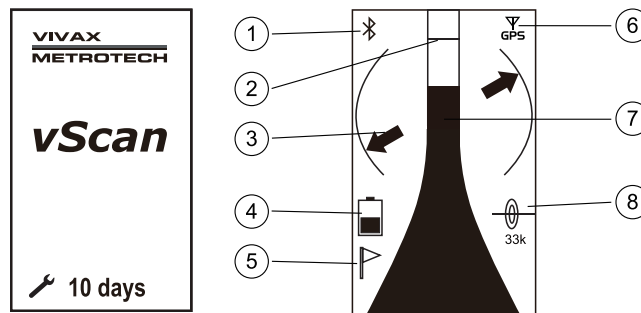







1	Bluetooth icon
2	Peak level indicator
3	Compass (line direction indicator)
4	Battery level indicator (also alert indicator)
5	Point of interest flag
6	GPS icon
7	Signal strength bar graph
8	Mode in use

3.1.2 Receiver Controls



1	Display
2	On/Off button. Also used to navigate in menu.
3	Depth/Current. Also long press enters menu option.
4	Fixed general purpose speaker
5	Mode switch. Also used to navigate menu functions.
6	Battery compartment. Also charging and data transfer sockets.
7	Removable headphone speaker
8	Sensitivity control
9	Removable wear boot

Locating Modes:

	Power mode
	Radio mode
	33kHz Active mode
	131kHz Active mode
	Dual Active mode 131kHz + 33kHz (Optional feature)
	Sonde mode
	Metal cover detection mode

3.1.3 Warnings/Alerts

Alerts

Warnings or alerts can be indicated by three different methods:

1. Audio - an audible warning sound will be emitted.
2. Vibe - a vibration device situated in the handle will activate.
3. Visual - an alert icon will replace the battery icon.



NOTE

The vScan will continue to operate in a warning/alert condition unless configured to “shut down”.

How warnings/alerts communicate their message is user configurable using MyvScan desktop application.

3.1.3.1 Shallow Line Alert



The shallow line alert will be triggered when a shallow line is detected.

3.1.3.2 Swing Alert



The swing alert will trigger if the angle of swing exceeds 30 degrees from the vertical. No alarm will be activated if the angle is more than 65 degrees from the vertical as it will be assumed that the locator is not in use at this time.

3.1.3.3 Signal Overload Alert



The signal overload alert will trigger if the input signal exceeds the allowable limits. This situation is very unusual and will only occur in extreme situations.

3.1.3.4 Overhead Signal Alert



The overhead signal alert is triggered if vScan detects a significant signal radiating from above, for instance an overhead cable.

Warnings

If configured in MyvScan, the startup screen will indicate the number of days to next service, such as:

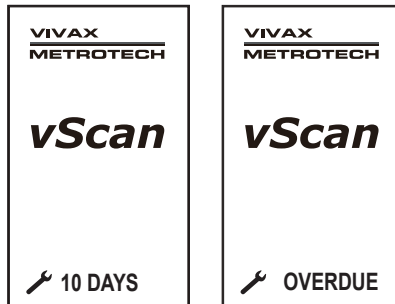

Other warnings will be displayed during start up if configured in MyvScan.

Icon	Warning	Action Required
	Upload Warning	Connect to MyvScan and upload the data log.
	Rental Expired Warning	Return to rental company.
	Cal Check Warning	Go to user menu and select "Cal Check". If it continues to fail, return to service center for repair.

These warning icons will continue to be displayed until the relevant action is taken.

If desired, the MyvScan desktop application can be used to configure these warnings so that if no action is taken the unit will shut down.

3.2 Transmitter

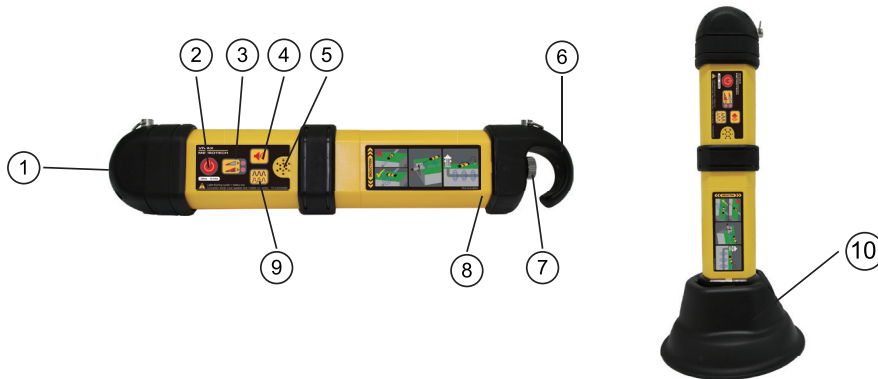

1	Direct connection socket	Automatically selects direct connection or signal clamp, when connected. Always ensure weather proof bung is replaced when not in use. If the connection socket is not being used, induction mode is selected automatically.
2	On/Off pushbutton	Long press to switch on. Long press to switch off.
3	Output level pushbutton	Press to change from battery save to high signal output.
4	Speaker volume pushbutton	High/low settings.
5	Speaker	Tone indicates connection quality.
6	Battery housing cover	Retains batteries and also has hanging hook.
7	Battery cover retaining screw	Hand tighten only.
8	Batteries	4 of D cells or bespoke rechargeable battery.
9	Pulse/Continuous pushbutton	Switch signal to pulse when in high noise environments.
10	Tx foot	Use to stand transmitter vertically when inducing over a wider area or nulling the signal over an unwanted cable/pipe.

NOTE



When using alkaline batteries, a black molded hook at the end of the transmitter is used to retain and connect alkaline batteries. If using the custom Lithium-ion rechargeable battery pack, the hook is built into the battery pack. All transmitters are supplied with the hook for the alkaline batteries even if rechargeable batteries are specified. This ensures that alkaline batteries can be used in the event the rechargeable batteries are fully discharged.

Locating

4.1 Switching the vScan Locator On and Off

To switch on, momentarily press the On/Off button. Allow a short period for the startup screen to show similar to the one below.



To switch off, press the On/Off button until the screen shows "Standby".

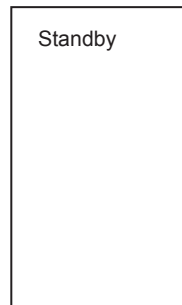

While in standby, the locator electronics are in a "sleep" mode using minimal battery power. After a set period (as set by MyvScan), the unit will automatically switch fully off. If, however, the On/Off button is momentarily pressed while in "Standby", the unit will revert to being fully functional in a very short period. A long press when in "Standby" will fully switch off the unit.

Note also, if the internal GPS option is fitted, the GPS unit is also powered when in "Standby" ensuring almost immediate functionality when powering up from the "Standby" screen.

Auto Shutdown

If set in MyvScan, after a period of inactivity the unit will automatically shut down. This is to avoid the unit accidentally being left switched on. Before shutting down, there will be a series of beeps warning the operator that the unit is about to switch off. The switch off can be cancelled by momentarily pressing either the "i" or "On/Off" button.

4.2 Passive Locating



NOTE
The compass indicator is not active during passive location.

4 Locating

Passive locating refers to the process of detecting signals that “naturally” occur on pipes and cables. These tend to fall into two categories, Radio signals and Power signals.

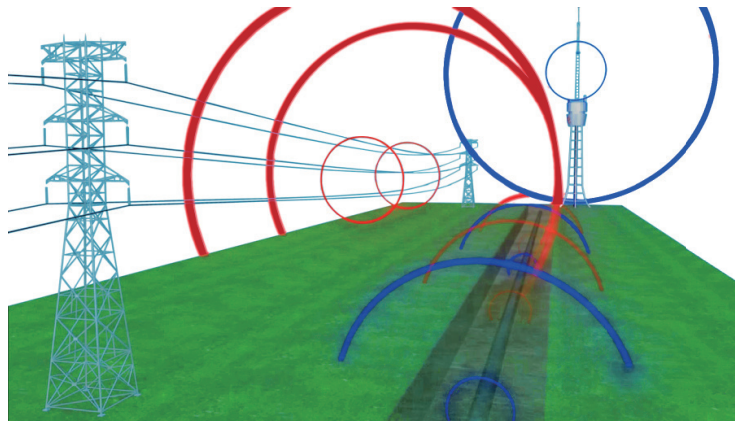

Radio signals are created by low frequency radio transmitters. These are used for broadcasting and communications. They are positioned throughout the world. As the frequencies are very low the signals tend to penetrate and hug the curvature of the earth. When the signals cross a long conductor such as a pipe or cable, the signals are re-radiated. It is these re-radiated signals that can be detected by the Radio mode.

Power signals are created by mains power running in the supply cables. These signals are 50 or 60Hz depending on country. For instance, the UK is 50Hz power but in the USA has 60Hz. When electrical power is distributed throughout the network, some of the power finds its way back to the power station via the ground. These stray currents can jump onto pipes and cables and also create power signals. Note that there has to be electrical current flowing to create a detectable signal. For instance, a live cable that is not in use may not radiate a detectable signal. Also a very well balanced cable, ie exactly the same current flowing in live and neutral, will cancel out and may not create a signal. In practice this is unusual as there is usually enough imbalances in the cable to create a good detectable signal.

4.2.1 Detecting Radio Signals

1. Switch on the vScan receiver and select Radio mode using the mode paddle.
2. Hold the vScan vertically and away from likely positions of cables or pipes.
3. Adjust the sensitivity control so that the bar graph reading is just starting to show some movement. The sensitivity control should be at or close to maximum sensitivity. Note that the compass feature is not available for the Power or Radio modes.

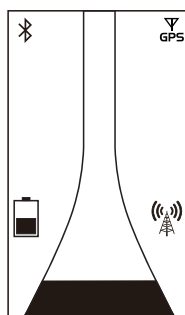

NOTE

Note that there will be no sound from the speaker until the meter reading is above approximately 10% of full scale.

4 Locating

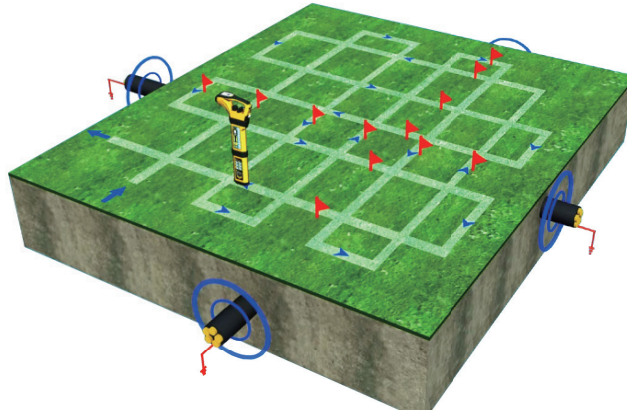

4. Keeping the vScan vertical, walk across the area to be checked.
5. Continue in a grid across the area.
6. If at any time, the meter reading starts to increase, carefully move the locator forward and back to detect the maximum signal. Use the peak level indicator to help confirm the correct position.

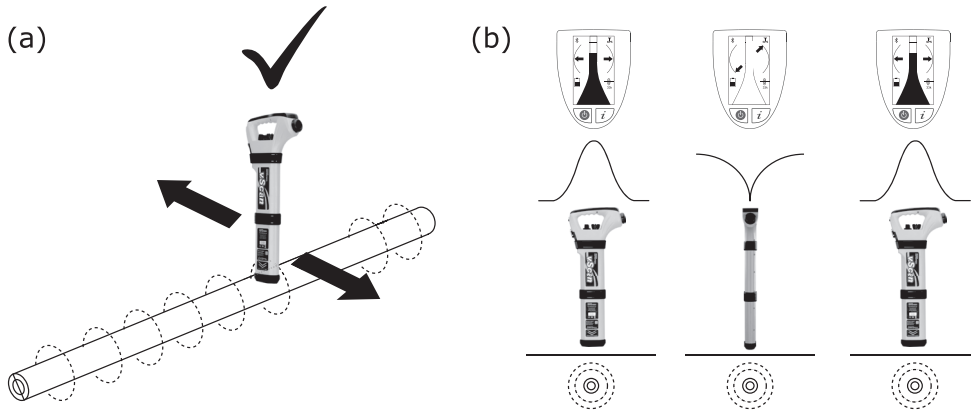

7. Rotate the vScan on its axis to obtain the maximum signal. The vScan is now directly over the line and with the blade across the line.
8. The direction can also be found by rotating until the smallest signal is detected. The blade is then in line with the cable/pipe.
9. Continue to locate the position of the line at regular intervals until its course is known through the target area.

NOTE



In busy environments it is not always possible to look at the meter and take note of traffic movements around you. In these situations, it is best to locate the position of the line using mainly sound rather than meter response. In very noisy situations even the speaker sound may be drowned out. In this instance, unscrew the speaker earphone and place it close to the ear to hear the sound from the detected line.

4.2.2 Detecting Power Signals

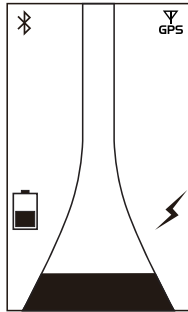

1. Locating Power signals is very similar to detecting Radio signals as they are both passive signals.
2. Hold the vScan vertically and away from likely positions of cables or pipes.
3. Adjust the sensitivity control so that the bar graph reading is just starting to show some movement. The sensitivity control should be at or close to maximum sensitivity.
4. Now follow the procedure described above in the Radio mode section.

4.3 Active Locating

The term “Active Locating” describes the action of locating a cable or pipe by detecting a specific signal that has been injected into that line. It has the benefit that, unlike passive detecting, the operator is in control of the signals and therefore can be more specific about what line is detected. That is to say active signals can be used for line tracing or identification. Also passive signals are not always present on a line so using active signals ensures more lines are detected.

To inject a signal requires the use of the vScan transmitter. The signal can be injected, or applied, to the target line in a variety of ways.

4.3.1 Direct Connection

This method involves making an electrical connection to the cable or pipe.



WARNING

When connecting to a cable, only connect to the sheath of that cable. The direct connection leads are not designed for connection to live cables.



WARNING

Do not touch metal parts of the connection clips when connecting to the line or when the transmitter is on.

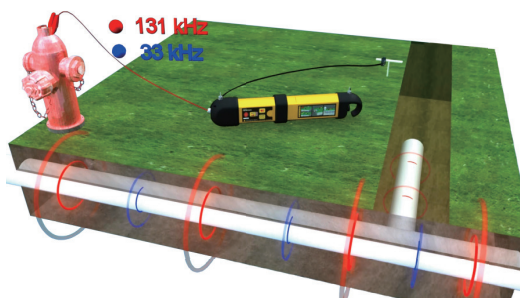

4 Locating



WARNING

Only authorized personnel should make connections to cables.

To make a direct connection, insert the direct connection connector to the vScan transmitter. Insert the ground stake into the ground a few meters perpendicular to the line. Connect the black lead to the ground stake. Now take the red lead and connect to the target line.

Switch on the transmitter by pressing and holding the on/off button down for a couple of seconds. The transmitter will emit a tone. The better the connection to the line and ground, the lower the tone will be. Check for a good connection by disconnecting and then reconnecting the red lead. If no tone change is heard, recheck connections.

Things that can affect the quality of connection are:

1. Rusty pipe connection point: clean the connection area with a wire brush.
2. Poor grounding: try inserting the stake into damp ground. Dampen the surrounding ground with water. If still an issue, try connecting to a manhole cover surround. Avoid connecting to fence railings as these may create return signal currents along the fencing that will interfere with the locating signal.

The output of the vScan transmitter can be set to battery save or high output levels. Always start with a low output and increase the output if the received signal is not strong enough. Setting the output to high when it is not required may result in some of the signal "bleeding off" onto other services and will drain more power from the battery.

Also note that the transmitter transmits two frequencies simultaneously (33 kHz and 131 kHz). The purpose of these two frequencies is explained in section 4.5, when to use 33 kHz or 131 kHz.

When connecting to a ferrous material, it is sometimes not possible to find a suitable projection to apply the connection clip. If this is the case, use the magnet supplied to make contact to the line and then clip the red clip to the magnet. A good example of this is to make a connection to a street lighting circuit. Usually it is the practice to connect the sheath of a lighting cable to the metallic inspection cover of a street lamp. Making a connection to the inspection plate will energize the cable via the plate and sheath. Usually there is no projection on the plate on which to clip so using the magnet on the plate provides a suitable clipping point.

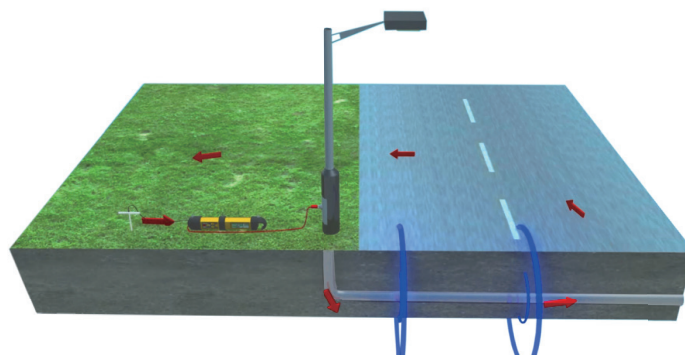

4.3.2 Signal Clamp

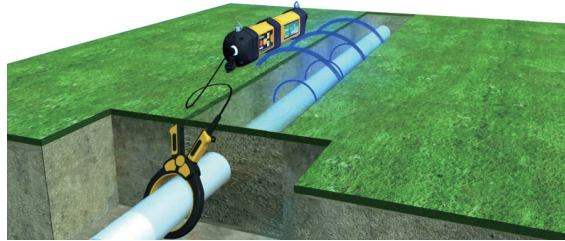

In many situations it is not possible to gain access to a cable for making an electrical contact. Or if there is, it is not safe to do so. The signal clamp provides an efficient and safe method of applying a locate signal to a cable.

Note that for best results the cable should be grounded at both ends.

When using the signal clamp, both ends of the target cable should be grounded to enable the current to flow. When applying a clamp close to a grounding point where multiple grounds or a grounding bus exists ensure that you place the clamp around the target line and not to the ground bus/other grounds to avoid the transmitted signal also being applied to an unwanted line.

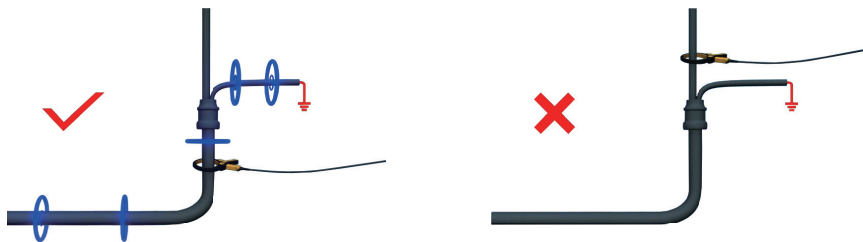

Clamp Extension Rod

A useful accessory to the clamp is the extension rod:

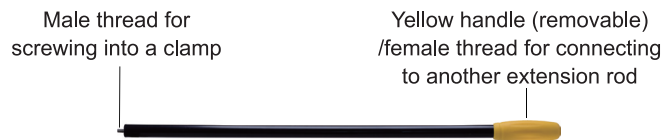

The extension rod is fitted with a 10mm threaded male stud. This male thread screws into the handle of the signal clamp to extend the distance of the clamp. This is very helpful for use in areas with difficult access such as in manholes or overhead cables. (Not to be used on uninsulated overhead power cables.)

The extension rod is also fitted with a female thread in the handle which enables the rods to be fitted together to further extend the range. To access this thread, slide the yellow handle off the rod.

To operate the clamp jaws when attached to the rod, gently pull on the clamp cord which will open the jaws. Release cable to close them.



4.3.3 Induction (33 kHz)

With no direct connection lead or signal clamp connected, the transmitter will automatically start to radiate a signal around the transmitter. These signals will penetrate the ground and couple onto buried lines. The signal will then travel along the line which can be detected with the vScan locator.

Applying an induction signal to a line.

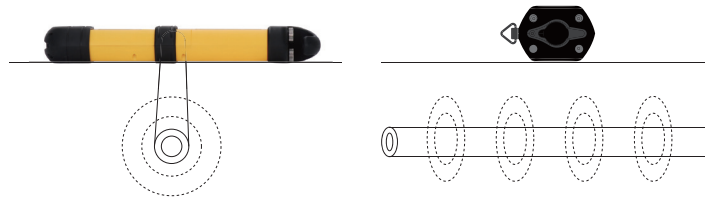

Remove any connections from the output connector. Switch on the transmitter and place it over the suspected position of the line and position it so that it is across the line as above.

The induction mode is particularly useful where there is no access to the line, but it should be noted that this is the least efficient method of applying a signal and it is also prone to signals being applied to adjacent lines.

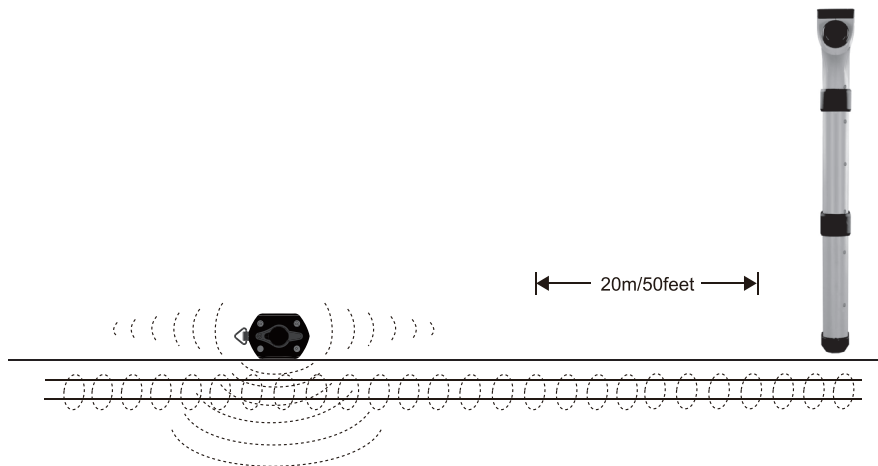

Also note that the signal will radiate out to the side of the transmitter as well as below. For this reason, it is recommended that when applying a signal using the induction method, a distance of at least 20m is kept from the transmitter when pinpointing or taking depth readings. Locating closer than 20m is possible but the operator should be aware that the signal directly received from the transmitter may be strong enough to influence the results.

4 Locating

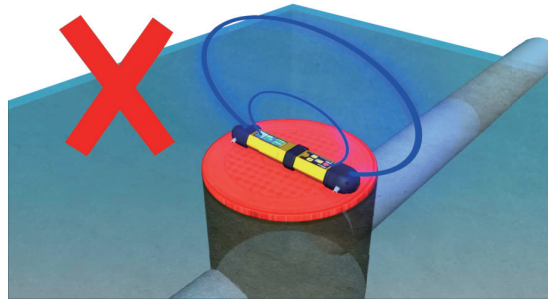

When using the induction mode, avoid placing the transmitter over metallic manhole covers as this will severely reduce the effectiveness of the transmitter and in extreme cases cause damage to the transmitter's circuitry.

4.3.4 Detecting Active Signals

Apply an active signal to a line using one of the methods outlined above in section 4.3, active locating.

Switch on the receiver and select a desired locate frequency. For general purpose, select 33 kHz.

Note that the screen will now show the addition of a compass (line direction indicator). In the presence of a locate signal the compass will align itself parallel to the line being located. This ensures that the operator is aware of the direction of the line.

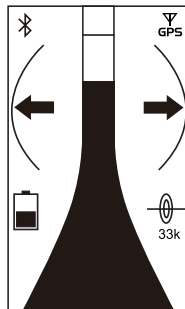

Hold the locator vertically and rotate it on its axis until the compass indicates across the display as above.

Adjust the sensitivity control so that the display indicates approximately 50%. Keeping the vScan vertical, move forward slightly. If the bar graph increases, you are moving toward the line. If it decreases, you are walking away from it. Move toward the line until a maximum signal is achieved. It may be necessary to reduce the sensitivity to keep the bar graph on scale. This is normal and should be expected. Try to keep the vScan vertical and avoid swinging it as this may create false readings.

Move the locator backward and forward to ensure a maximum signal is detected. Use the peak level indicator to assist.

With the maximum signal found and the compass running across the bar graph, the vScan is now directly over the line and exactly across it.

Continue to trace the line to its destination or source.



NOTE

The compass will not rotate through a full circle as the bar graph is in the way. When the compass is outside the range of rotation the arrows will appear as line drawings. To bring back within the range of the compass, rotate the locator in the direction as indicated by the arrows.

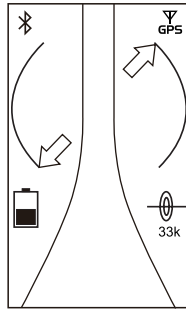

4.4 Taking Depth and Current Measurements

If the depth measurement feature is activated, it is possible to take depth measurement estimations. To take a depth measurement, first pinpoint the position of the line as above. Place the tip of the vScan on the ground making sure it is vertical and across the line. Momentarily press the “i” button. The screen will change to a screen similar to the one below.

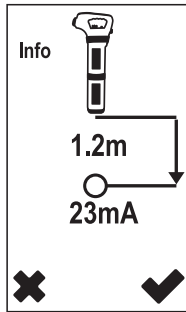

If the current measurement feature is activated, the signal current value will also be displayed. This feature is useful for confirming that the detected signal is radiating from the correct line. In the event the signal is “bleeding off” onto other services, these signals will generally be less than that of the originating signal. However, care should be taken as the signal current will gradually reduce over the length of the line, but watching for a sudden drop in current over distance should indicate that either:

1. There is a ground fault on the line which is shunting signal to ground.
2. There is a “T” off from the mainline.
3. The operator has migrated from the connected line to a line which has some signal that has bled off from the main line.

Note that the current reading will only be displayed if 33 kHz or 131 kHz modes are selected.

4.4.1 Depth in power mode

Typically, depth in the power mode is not available. This is because the signals radiating from power cables are more likely to be distorted so the measurements are more likely to be affected. However, some models have depth in the power mode active. If your vScan has its depth in power enabled be sure to take extra precautions when taking depth readings.

4.4.2 Checking for depth errors due to signal distortion

One way to determine if the depth measurement is likely to have been affected by distortion is to take a depth reading at ground level, then raise the vScan a known distance such as 0.5m. Retake the depth reading at the new depth and confirm that the depth has increased by this amount. If the depth has changed by something other than the actual change, then the readings should be treated as suspect.



WARNING

Never mechanically dig over the path of a buried pipe or cable. Always dig carefully.

4.5 When to use 33 kHz, 131 kHz or Dual(131 kHz + 33 kHz) Mode

Apart from the induction mode, the transmitter transmits both 33 kHz and 131 kHz simultaneously, so no adjustments are required on the transmitter.

As a general rule 33 kHz will provide the best compromise between clarity of signal and effects of “bleed off” to other services. However, there are times when the high 131 kHz frequency will be beneficial. These are:

1. Locating pot ended cables: Pot ended cables are generally not grounded. This means that the signal will not readily travel to the pot end. Using a higher frequency will encourage signal current to flow.
2. Small diameter cables: Higher frequencies tend to flow better on small diameter cables, although the rule “first try 33 kHz” still applies.
3. Locating old cast iron pipes: These tend to have mechanical connections between sections which rust over time and prevent an electrical connection between pipe sections. The 131 kHz signal will tend to jump across these joints and continue down the line.
4. Poorly grounded cables: Generally, higher frequencies will travel along a poorly grounded cable better than lower frequencies.

Dual mode is available on some models. It can be used when it is not clear which frequency will give the best result. When switched to Dual Mode the locator will detect both signals simultaneously. The speaker will emit a dual tone, a low pitched tone representing 33kHz and a high pitched tone representing 131kHz. If one signal is particularly stronger than the other, it may only be possible to hear one tone.

When in Dual mode 33kHz is used to measure depth.

4.6 Metal Locate Mode (vScanM Cover Detector)

The metal locate mode is used to detect buried manhole covers. For this feature, be sure to order vScanM. The cover locator has been designed to respond to most metal covers.

4.6.1 Locating a Buried Cover

Before locating a buried cover it is necessary to perform a simple set up procedure.

Switch on the vScanM and select the cover detection mode using the mode switch. The cover detection icon should be shown on the screen.



Hold the vScanM well away from any metallic objects.

Momentarily press the “On/Off” button. The bar graph will show close to zero deflection and there should be a slow pulse sound from the speaker. The unit is now set up.



NOTE

The sensitivity control does not function when using the M mode.

Hold the locator just a small distance from the ground (approximately 2” or 50mm). Now sweep the area in a grid action in a similar way to sweeping for a buried cable. Keep the locator vertical and avoid swinging it. As a metallic object is approached, the bar graph will start to deflect more and the speaker tone will increase.

Find the peak signal by moving the locator forward and back and then side to side. Use the peak level indicator to help pinpoint the position of largest signal. The largest peak signal will indicate the position of the center of the buried cover.

4 Locating

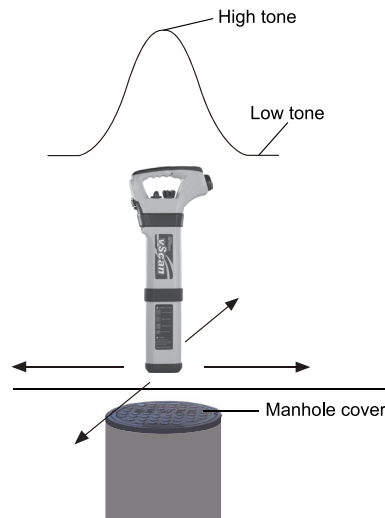

4.7 Locating Non-metallic Pipes or Ducts

Locating non-metallic pipes or ducts is not possible using conventional locating techniques. However, it is possible to detect small transmitting devices (Sondes) if they are inserted into a non-metallic pipe or duct. Sondes are available in a range of sizes and transmitting ranges. A popular one is the D38 Sonde that has a diameter of 38mm and a range of 5m.

The Sonde is typically attached to a drain rod (10mm fitting) and pushed down the pipe or duct and periodically located as it is pushed along.

Locating Sondes method:

1. Switch on the Sonde by connecting the battery. Connect it to the pushrod and place it in the start of the pipe run.
2. Switch on the vScan and select Sonde mode using the mode paddle. The Sonde icon will now be visible on the screen.



3. Position the vScan above the Sonde as indicated below: (The rotational orientation of the receiver is 90 degrees to that used when line locating)

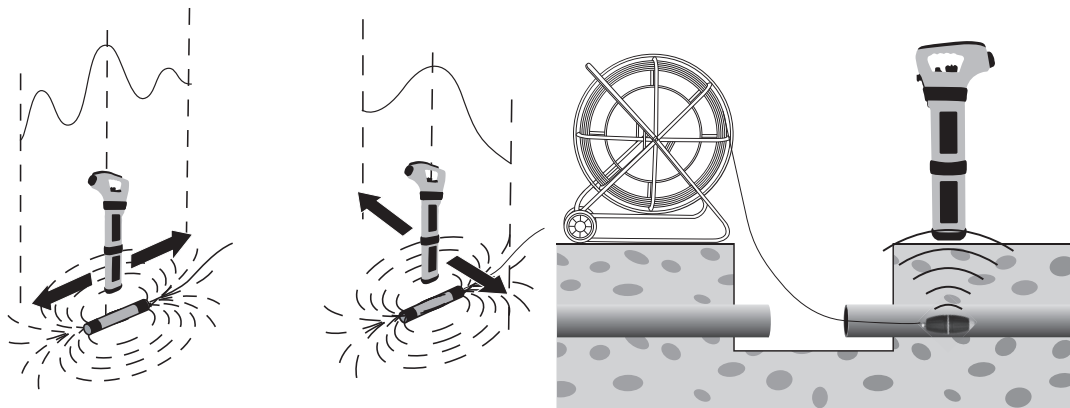

4 Locating

- Adjust the sensitivity control so that the bar graph reads approximately 75%. Now move the vScan forward and back to detect the largest signal. You will also notice that there will be a “ghost signal” in front and behind the Sonde. This is normal and characteristic of locating Sondes.

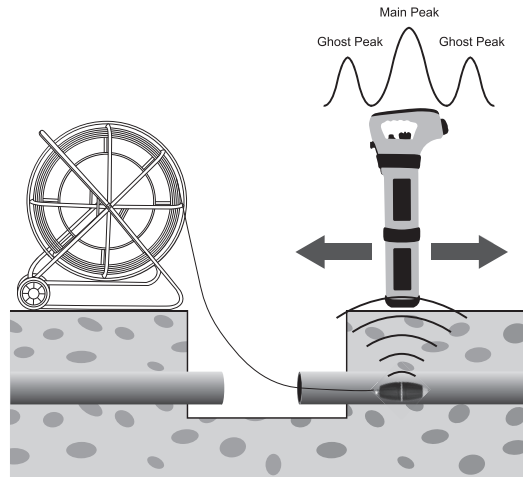

- Now sweep left and right over the Sonde to obtain a second peak. Note that there are no ghost signals when sweeping left to right over the Sonde.

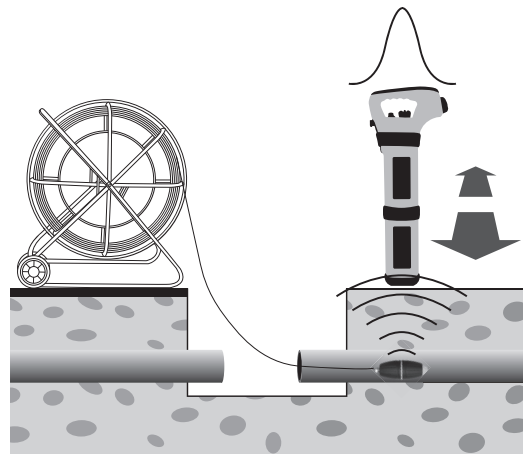

- Finally check that the vScan is in line with the Sonde by rotating it on its axis to obtain a peak signal. The vScan is now over the Sonde and in line with it.

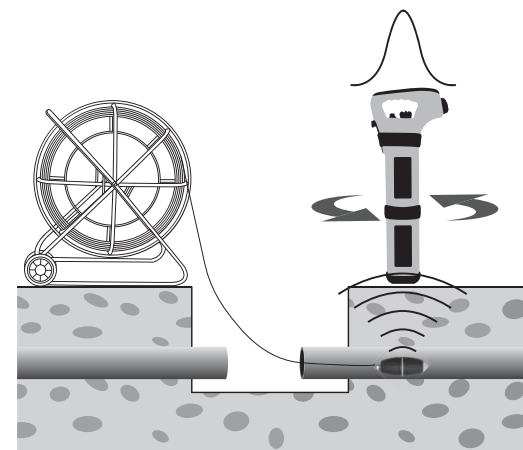

4 Locating

7. If a depth estimation is required, place the vScan on the ground having pinpointed the Sonde as above. Momentarily press the “i” button and the depth will be displayed. To exit the depth screen, either wait for the depth screen to “time out” or momentarily press the on/off key which will return the vScan to the locate screen.
8. Now push the Sonde in a couple of meters and repeat the above to mark out the route of the pipe or duct. Keep the insertion intervals small (2 to 3m) so as to ensure the Sonde is not lost.

Using the vScan to Locate Camera Heads (vCam range)

Some vScans have a low frequency Sonde mode activated, either 512Hz or 640Hz. These modes are designed to be compatible with the vCam range of sewer inspection cameras. Refer to the relevant vCam user manual for full instructions on locating camera heads.

4.8 Advanced Locating Techniques

4.8.1 Two Person Sweep

This is an induction method technique and is used to quickly check an area for any metallic services.

Method:

1. Select the area to be checked. One person holds the transmitter and the other holds the vScan receiver.
2. Attach the carry strap to the transmitter. This is important as it makes carrying the transmitter more comfortable and allows the transmitter to be held close to the ground ensuring maximum coupling to the services below.
3. Switch on the vScan and select 33 kHz line mode.

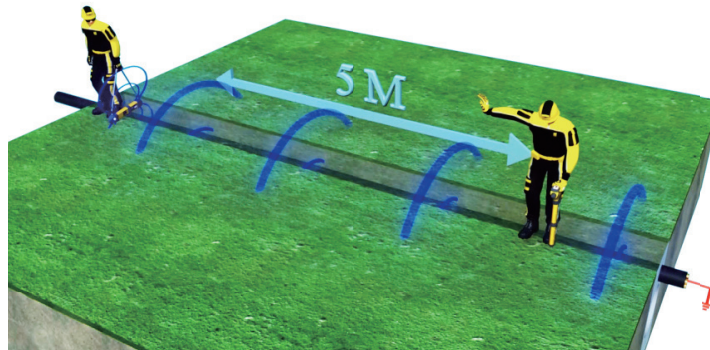

Stand at least 5m apart holding the equipment as below, i.e. with the transmitter and receiver in line with the direction of walking.

Adjust the sensitivity of the receiver so that the meter reads approximately 20%.

Walk slowly across the site keeping parallel with each other. As a service is approached the signal level on the receiver will increase. When the signal is at a maximum, stop the transmitter and place it on the ground. Then pinpoint the position of the service with the receiver in the usual way. Mark this position and if necessary plot the route across the site.

Continue the sweep across the site and then, if possible, repeat the process at 90 degrees to the sweep already done.

4.8.2 “Swamping” an area with Signal (broad induction)

A quick way to check an area for services is to “swamp” the area with signal. To do this, insert the transmitter into the Tx foot supplied with the transmitter and place on the ground as shown in the picture.

4 Locating



Switch on the transmitter. The Induction signal will radiate outward through 360 degrees into the ground ensuring any cables and pipes in close proximity to the transmitter will have signal induced into them

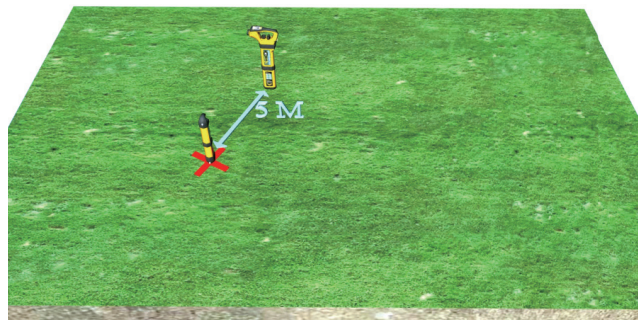

Position the vScan receiver approximately 10m from the transmitter and with the flat of the blade pointing directly at the transmitter. Switch it on and adjust the sensitivity so that approximately 20% reading is observed.

Walk slowly around the transmitter watching for an increase in signal level. At an increase, pinpoint the source of the signal and mark the ground at the maximum point. Repeat until the complete circle is checked. Finally check the route of the services detected by placing the transmitter in the more conventional way (ie flat on the ground and across the direction of the service) and tracing the signal though the area.

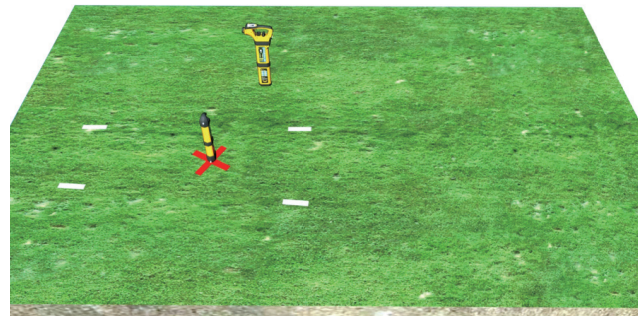

Note that, when the transmitter is positioned vertically as above, there is no signal induced directly below the transmitter. It is therefore necessary to move the transmitter approximately one meter to the side and repeat the locate exercise in case a service crossed directly below.

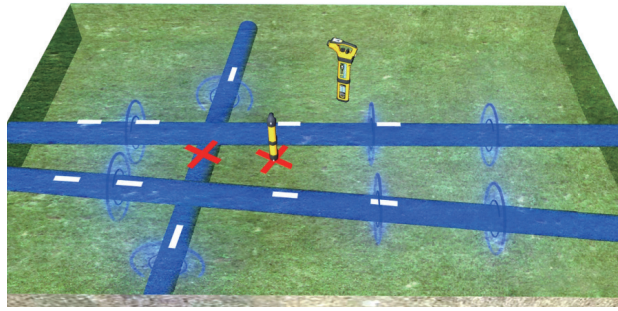

4.8.3 Nulling Out a Signal (Induction Mode)

In congested areas it can be difficult to trace a particular service. This is generally the case when two or more services are routed close to each other along, for instance, a pathway. Using the induction mode in this situation will make the situation worse as the signal will induce on to adjacent services as well as the target service.

This situation can be greatly improved by using the “nulling out” technique.

Method:

1. First locate the services using induction in the usual way.

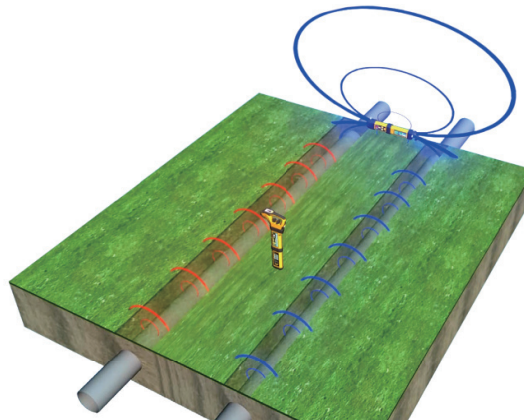

2. Now position the vScan receiver exactly over the unwanted signal. The person at the transmitter end can now hold the transmitter vertically over the position of the unwanted signal. Move the transmitter side to side across the line of the unwanted service whilst asking the person at the receiver end to indicate when the signal is “nulled out”. Insert the transmitter into the Tx foot and place in the null position.

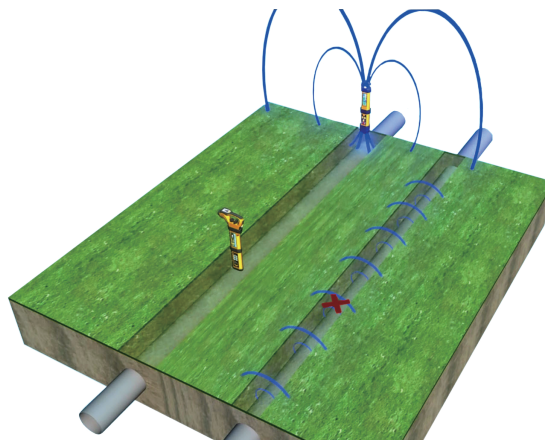

4 Locating

3. The signal should now only be visible in the wanted service but not on the unwanted service.
Note that only one service at a time can be nulled out using this method, so if there are more than two services the above may need to be repeated to null out other services.

4.8.4 Capacitive Coupling

There may be times when direct connection is not possible and it is not possible to deploy a signal clamp as a means of signal injection. If this is the case an alternative is to use the “capacitive coupling” technique. This uses the high frequency (131 kHz) part of the signal. The high frequency has the ability to couple to a service just by being in close proximity to it.

Method:

1. Identify the service to be energized. Wrap the red direct connection lead around the cable. If possible, wrap more than once round as the more surface area close to the cable the better. Take the black lead and connect it to a suitable ground. Create your own ground if possible using the ground stake.
2. Switch on the transmitter. Note that there will not be a tone change to indicate a good connection as only a very small amount of signal will be transferred to the cable but there should be enough to trace the cable for a short distance.

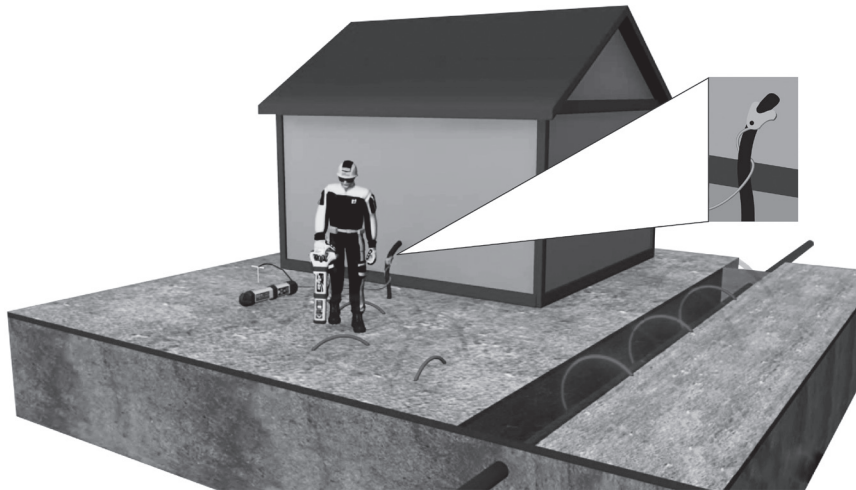

4.9 Self-Test/Calibration Check

4.9.1 The vScan Receiver

The vScan has been designed to be a robust and stable avoidance tool. However, as with all safety equipment it is advisable to check the functionality of the equipment. As the receiver is the signal processing part of the kit, Vivax-Metrotech has designed into the equipment a calibration and functionality check.

Results are automatically recorded within the equipment and can be used in conjunction with MyvScan to print out calibration check certificate and to store a complete self-test history of the receiver.

Method:

1. Firstly identify an area that is free from cables and erroneous signals such as computer monitors, extraction fans, fluorescent lighting etc. If in doubt, switch to each mode and with the sensitivity set to maximum, check that the background noise is below 10% of full scale deflection. Also check that there are no activated vScan transmitters in the vicinity.
2. Switch on the receiver and press the “i” button until the “Menu” screen appears.
3. Use the paddle to navigate down to the “Cal Check” option. Press the “i” button to initiate the test.

4 Locating

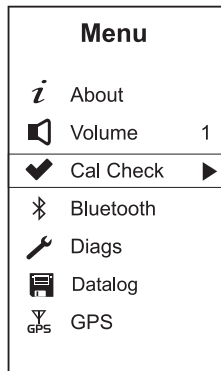

4. While the unit is performing the test the following screen may appear. (Some models do not have this screen but the process is the same)

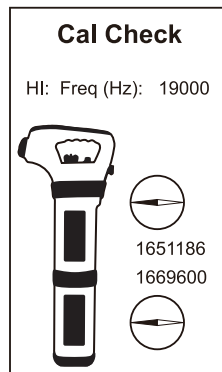

5. If the unit passes the tests, the following will be displayed. The results are automatically stored with the equipment and can be reviewed later with the aid of MyvScan management tool.

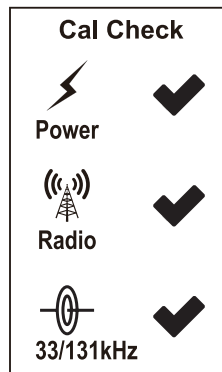

6. If one or more parts of the test fail, the ticks will be replaced by a cross at the relevant position. If this occurs try the test again in a more noise free environment. If the unit continues to fail the tests, return to Vivax-Metrotech or one of its approved repair centers for further investigation.
7. Note that this test does not test the metal cover detector of the vScanM. To check this, simply check that the unit detects a 6" (150mm) metal cover at a range exceeding 6" (150mm).

4.9.2 vScan Transmitter Check

As the transmitter is not a measuring device, it is not necessary to perform calibration checks on the equipment. However, it is advisable to perform this quick and easy functionality check.

4 Locating

Method: Induction

1. Set the transmitter down on a wooden chair or table so that it is off the ground. Set it in the orientation as shown.



2. Switch on the transmitter and set the output to low. Set the receiver to 33 kHz Sonde mode. Set the sensitivity control so that the largest notch is pointing directly at the mode switch as below.



3. Slowly alter the distance from the transmitter until the meter just reads full scale. Check the distance from the transmitter is 2.0 to 3.0m.

Method: Direct Connection

1. Connect the direct connection leads to the transmitter. Switch on the transmitter and set to low output. Short the two crocodile clips together and note a major change in speaker tone.
2. Switch the output to high and listen for a further drop in tone.
3. If there is no change in tone, check the condition of the direct connection leads and if possible try a different set of leads. If there is no change still, return to Vivax-Metrotech or one of its approved repair centers for further investigation.

4.10 GPS

GPS is a factory fit option that must be requested at the time of ordering.

The function of the GPS feature is to attach positional information to any recorded logs. The process is automatic and does not require further interaction from the operator. The accuracy of the data will vary depending on satellite availability and quality of satellite signal. Satellite availability will vary throughout the day but should be adequate at all times. Things that can affect the quality of signal are:

- Working in built up areas. This causes the signal to bounce off buildings and creates errors. Working close to high rise buildings for instance will affect the signal more than low buildings.
- Dense overhead foliage such as large tree branches.

With good satellite reception, a 5m or better accuracy should be possible in the majority of instances.

For positional information to be attached to records a valid GPS signal must be detected. If no GPS data is being detected, the record will still be logged but without GPS data.

If the GPS option is fitted, a GPS icon will appear on the screen. The condition of the GPS signal can be determined as below:

- No GPS icon = GPS not fitted

4 Locating

- Flashing icon = GPS not receiving a valid signal. Looking for satellites.
- Solid icon = valid GPS signal detected.



NOTE

Note that when the unit is switched on the GPS icon may flash for a prolonged time as the GPS circuitry takes time to acquire satellites. This time will vary depending on satellite availability. The first time the unit is switched on it may take up to five minutes to detect a valid signal, but subsequent times should be much less.

Note that there will be no satellite access within buildings.

The vScan has quick start up circuitry for the GPS. It works by holding power to the GPS circuitry for a period of 30 minutes (or as set by MyvScan) after switch off. The circuitry is activated when the unit is put into the “Standby” mode. If the unit is switched back on, from the “Standby” mode, within the 30-minute time period and providing there is GPS availability, the GPS lock will be almost instant.

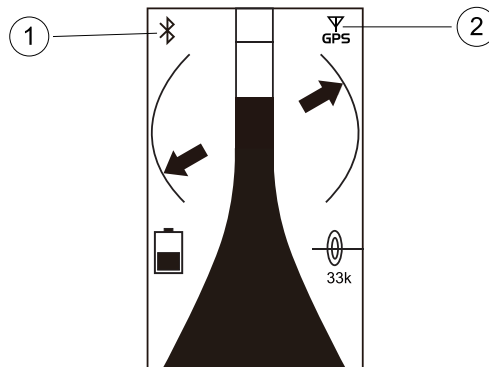

1	Bluetooth icon
2	GPS icon

To extract the data from the vScan, see section 4.14, MyvScan.

4.11 Using an External GPS

If the unit is fitted with the Bluetooth option (see section 4.13, Bluetooth), it is possible to select an external GPS device. This may be desirable if, for instance, a high accuracy GPS is required.

To select an external GPS, enter the menu by a long press on the “i” button. Use the paddle to scroll down to “GPS”. Note that the screen will show the active GPS data and at the top of the display will be the text “Source Int”.

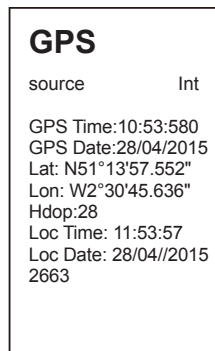

4 Locating

This indicates that the internal GPS is selected. To select an external GPS, press the “I” button. The text will now change to “Source Ext”.

Exit the menu by momentarily press the On/Off button.

Note that if the Bluetooth option is not fitted it will not be possible to select an external GPS. It will now be necessary to pair with an external GPS. (see section 4.13)

Also note that if an external GPS is selected the GPS icon in the locate screen will also show the GPS icon with “GPS EXT” written below it.

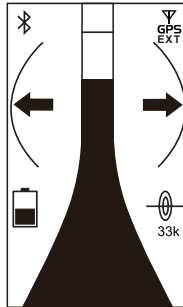

4.12 Creating “Points of Interest” (POI)

Sometimes it is desirable to create lines or points of interest that can be easily extracted from the data log. To do this, double click the “I” button. A flag will appear on the screen indicating that this portion of the data log is being highlighted. For a point of interest, remain in the same spot and double click again to remove the flag.

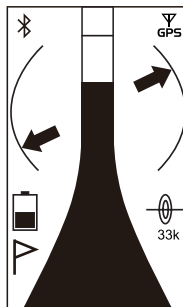

To create a line of interest, double click to create the flag. Locate the section of line which is of interest and then double click again to stop the section being highlighted.

Use “MyvScan” to retrieve that data. Section “Data Management”/ “Set Filters” sets the conditions to retrieve the data or use a predefined template (Areas of Interest).

4.13 Bluetooth

Bluetooth is a factory fit option that must be requested at the time of ordering.

The Bluetooth feature enables the vScan to communicate with external devices, such as high accuracy GPS and data logging devices, via a radio link.

Before data can be exchanged with the external device, the two units need to be electronically paired. The vScan screen shows the status of the Bluetooth via the Bluetooth icon:

4 Locating

- No icon = Bluetooth not fitted or has been deactivated in the menu.
- Icon flashing = Bluetooth is activated but not paired with a device.
- Icon solid and not flashing = Bluetooth is paired with a device.

Note that if the unit is paired with an external GPS, the icon will display “GPS EXT” under the icon.

Pairing devices:

1. Switch on the external device and ensure it is within a couple of meters of the vScan receiver.
2. Pairing achieved through the setup menu. To enter the setup menu, press and hold the “i” button.
3. Use the mode paddle to navigate to “Bluetooth”.

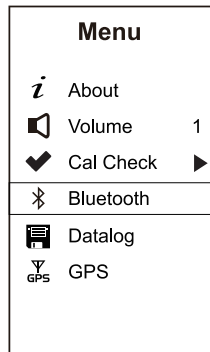

4. Press the “i” pushbutton. The vScan will now show two options:
 - a. Pairing
 - b. Search ON (Search Off)
5. Use the paddle to navigate to “Pairing”. Note that the Search On/Off option will automatically switch to On activating the Bluetooth. The unit will now automatically search for suitable devices.

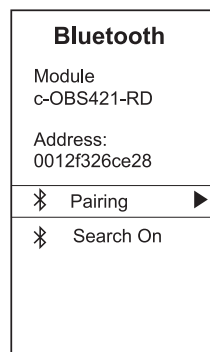

After a short period a screen similar to the one below will be shown. Note the list shown is an example. The actual list will represent the available devices:

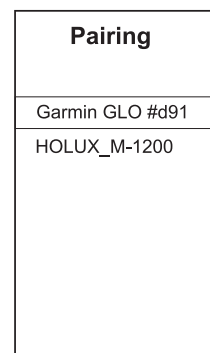

4 Locating

6. Use the paddle to highlight the desired device and press the “i” button to select it.
7. The locator will automatically revert to the locate screen and the Bluetooth icon will now be solid, i.e. not flashing. (If it does not revert automatically, press the On/Off button to exit the menu)
8. Unless changed in the menu, the vScan will automatically pair with the external device at subsequent start-ups.

TIP

When the Bluetooth icon is flashing, the Bluetooth module is emitting strong radio signals that will interfere with the Radio mode. Once the unit is paired, the effects are minimal. For this reason, it is strongly advised that the Bluetooth feature is disabled if not in use.



To disable the Bluetooth module, select Bluetooth in the menu.

Note the Bluetooth module setting. If “Search On” is highlighted use the toggle paddle to scroll down to this feature and use the “Information” button to change the selection to “Search Off”.

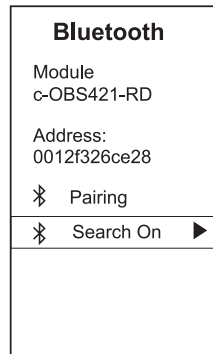

Exit the menu and check that the Bluetooth icon is no longer visible in the top left hand corner of the display.

The vScan will exchange data with the external device every second creating logged data points.

If data logging to an external device, it will be necessary to configure the external data logger to accept the format of the data stream. For more details on the vScan data stream visit www.vivax-metrotech.com.

4.14 MyvScan

MyvScan is a powerful software package which supports features available in the vScan receiver product range including vScan and vScanM.

MyvScan can be downloaded from the website: www.vivax-metrotech.com

MyvScan enables the user to:

- Configure the locator
- Select locator features
- Select defaults
- Manage warning, test & calibration and service schedules

4 Locating

Data Management

- Select and manage data and data files
- Produce reports
- Print calibration check certificate
- View, save and export reports

About

- Register Product
- Update Locator and desktop application software
- Set location of data files on computer. (Default settings are set by the program)
- Contact us
- Help

4.14.1 Using MyvScan

If not already done, download and install MyvScan from the Vivax-Metrotech.com web site.

Launch MyvScan by double clicking on the MyvScan icon.



To start using MyvScan, you must make a connection to a locator. With the unit switched off, open the battery compartment door to reveal the mini USB socket. Connect a suitable lead with a standard USB connector on the other end. Connect to a standard USB port on your computer.

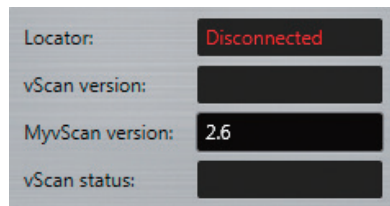

With the locator switched off the bottom left of the home screen will show the above.

Switch on the locator and the text will turn green and display "Connected" as below. Note that the software revision of MyvScan (not to be confused with the locator software) will also be displayed together with the vScan lock status. To unlock or lock the vScan requires the use of the lockout dongle.

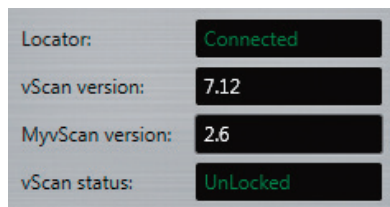

4.14.2 Navigating around MyvScan

When MyvScan is first launched you will see the home page as below:

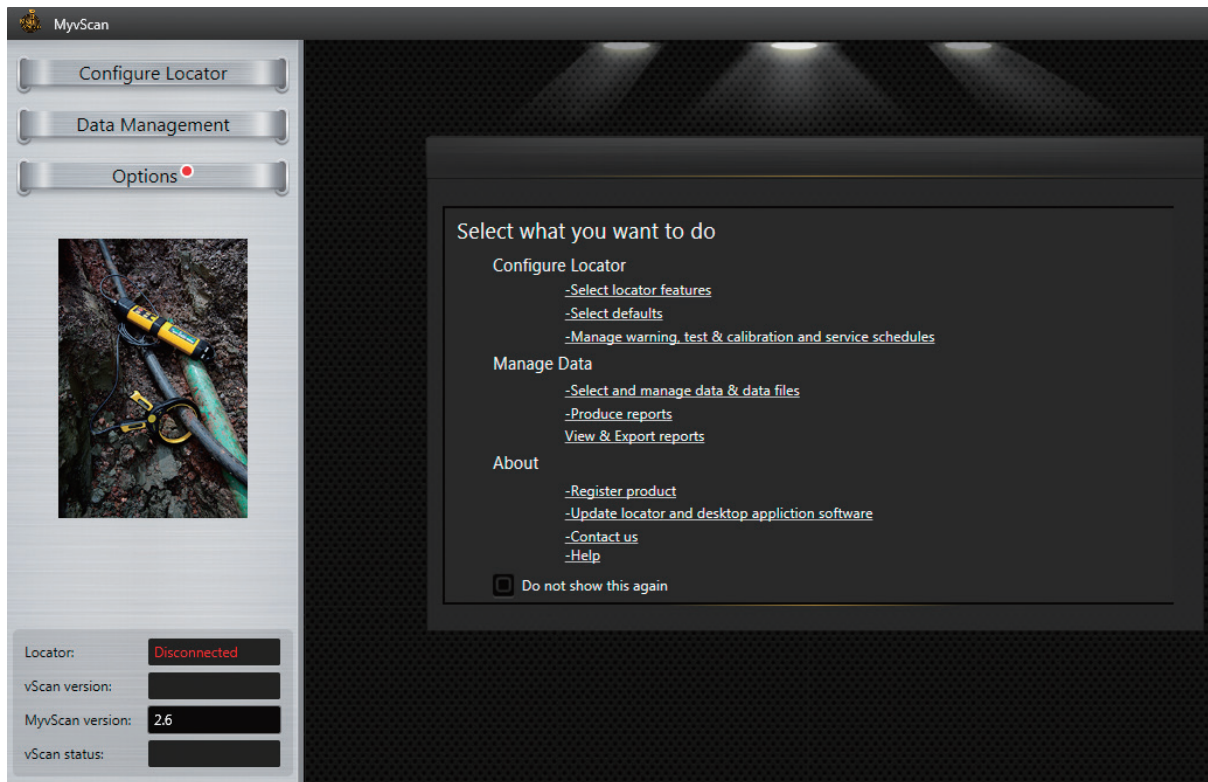

The screen is split into two main areas:

- To the left you have the three main options:
 - Configure Locator
 - Data Management
 - Options (Note that a red dot will appear on the Options bar if a software update is available)
- To the right is a first time use page that helps describe the features available. Checking the “Do not show this again” box will prevent it from displaying on future when switched on.

Clicking one of these will also reveal a sub menu relating to these topics.

To the right the black area is your work area relating to the selection you have made on the left.

4 Locating

The right hand side also has some navigation aids:





The arrows to the left and right allow you to navigate to the next or previous screen.

The numbers and ticks along the bottom indicate how many pages are associated with the area and how many have been visited.

Follow the on-screen instructions and make selections as necessary.

MyvScan is under continual development, therefore screens and instructions may change from time to time.

Glossary

Active Locate	A locate where a transmitter is used to apply a signal to a buried pipe or cable, the position of which is then located by a receiver tuned to the same frequency.
Active Signal	A signal applied by the locator transmitter to a buried line. Typically this is a very precise frequency.
Attenuation	The reduction of an electromagnetic signal from a pipe or cable.
Clamp (or Coupler)	An accessory used to apply the transmitter signal to an insulated line, removing the need to connect the transmitter signal directly to a conductor or cable sheath.
Compass	Line direction indicator (although visually like a compass, this is the only relation to a compass.)
Coupling	The act of signals transferring to lines to which they were not originally applied. Coupling can be "direct" where the target line has an electrical connection to another line, or "induced" where the signal radiates from the target line to another line or lines.
Display	The information visually available on the dot matrix display.
Line	A generic term for any buried pipe or cable.
Null	A minimum response to a buried line. 
Passive Locate	A locate where the receiver searches for a wide range of signals that radiate from buried pipes or cables. These signals come from a variety of sources in the environment and couple to the buried (& overhead) lines. Typical examples 50 / 60Hz and LF/VLF radio.
Passive Signals	A wide range of signals that radiate from buried pipes or cables. These signals come from a variety of sources in the environment and couple to the buried (& overhead) lines. Typical examples 50/60Hz and LF/VLF radio.
Peak	A maximum response to a buried line. 
Pinpoint	Using a receiver to identify the exact position of a buried line.
Response	The indication that the receiver gives which is caused by the signals it is receiving. This can be visual, audio or both. Typically it is displayed on the locators dot matrix display and audibly from a loudspeaker in the receiver housing.
Search (sweep)	This describes the act of looking for a buried line within a given area.
Sonde	A small transmitting coil which may be built into a product such as a sewer camera or packaged as a small self-contained battery powered transmitter. A receiver tuned to the same frequency can locate the position of the Sonde and hence whatever it is attached to or in. Frequently used for locating sewer cameras, and the non-metallic pipes.
Target Line	The buried pipe or cable to be located.
Trace	Using a locator to following the path of a buried line.

.....

Illustrations used in the preparation of this manual will inevitably show some resemblance to similar illustrations from other Manufacturers-some manufacturers have given permission for the use of their graphics and is given credit for such use. This statement is intended to attribute such credit.

.....

Disclaimer: Product and accessory specification and availability information is subject to change without prior notice.

