



vCamMX-2 User Handbook (English Edition)

Version 1.0

P/N:4.04.000132



Table of Contents

1.	General Safety Instructions.....	1
1.1	Health and Safety.....	1
1.2	Worksite Safety.....	1
1.3	Equipment Safety.....	1
1.4	Batteries and the Environment.....	1
1.4.1	Alkaline Batteries (Sondes, Light Kits or Locators).....	1
2.	Service & Support.....	2
2.1	Model and Serial Number Location.....	2
2.1.1	Control Module and Reel Serial Number Location.....	2
2.1.2	Camera Head Serial Number Location.....	2
2.2	Firmware Revision Location.....	2
2.3	Request for Service.....	3
2.4	Distributors and Service Centers.....	4
3.	Introduction.....	5
3.1	The vCamMX-2 Inspection Camera System.....	5
3.2	What's in the box.....	5
3.3	vCamMX-2 Series Control Module Overview.....	6
3.4	Type-MX Cable Reel Overview.....	8
4.	Initial Control Module Setup.....	9
4.1	Initial Control Module Setup.....	9
4.1.1	Installing the Fuse.....	9
4.1.2	Charging the Internal Battery.....	9
4.1.3	About Control Module Settings.....	10
4.2	Navigating through the Setup Menu.....	10
4.2.1	Key used in the setup procedure.....	10
4.2.1.1	Turn on the system.....	10
4.2.1.2	Set the Language.....	10
4.2.1.3	Set the Distance Counter Units.....	10
4.2.1.4	Set the Date and Time.....	11
4.2.1.5	Set the Storage Options.....	11
4.2.1.6	Set the Sonde Frequency.....	11
4.2.1.7	Set the OSD (On Screen Display) Options.....	11
4.2.1.8	Set the File Rename Option.....	12
4.2.1.9	Set up Wi-fi.....	12
4.2.2	Wi-Fi Administration.....	12
4.2.3	Restore the Factory Default Settings.....	12
4.2.4	Update the Control Module Firmware.....	13
5.	Video Recording and Image Capture.....	16
5.1	Overview.....	16
5.2	Recording a video and capturing JPEG pictures.....	16



5.3	Viewing Recorded Videos and Pictures in the Control Module.....	17
5.3.1	vCamMX-2 File Manager Overview.....	17
5.3.2	Viewing and playing contents of the USB drive or SD Card.....	17
5.3.3	Copying files.....	17
5.3.4	Deleting files.....	18
5.4	Troubleshooting Video Playback.....	18
5.5	AVI Video Format.....	18
5.6	Getting Codecs.....	18
5.7	File Associations.....	18
5.8	Other Media Players.....	19
6.	Features Available During Recording.....	21
6.1	Voice Over.....	21
6.2	Volume Control.....	21
6.3	Display and Backlight Settings.....	21
6.4	On-Screen Status Bar.....	21
6.5	On-Screen Display (OSD Info).....	22
6.6	Camera LED Light Control.....	22
6.6.1	From the Media keypad.....	22
6.6.2	From the LCD Keypad.....	23
6.7	On-Screen Text Writer.....	23
6.7.1	Introduction to the on-screen Text Writer.....	23
6.8	JPEG Image Capture.....	26
6.9	Digital Zoom.....	26
7.	Wi-Fi and Ethernet.....	27
7.1	Wi-Fi Connection for Apps.....	27
8.	Cable Reels.....	28
8.1	Using the Cable Reels.....	28
8.1.1	Pushrod Cable.....	28
8.1.2	Using the Cable Reel.....	28
8.1.3	Deployment of the Pushrod Cable.....	29
9.	Camera Heads and Terminations.....	32
9.1	Parts of the Camera Heads.....	32
9.1.1	Camera Head Options.....	32
9.2	Spring Termination Parts.....	33
9.2.1	Termination Parts List.....	33
9.2.2	Pre-checking the Camera Head Before Installing.....	33
9.2.3	Pre-checking for Picture and LED Control.....	33
9.2.4	Pre-checking the Camera Glass Lens and LED Cover.....	34
9.3	Removing and Installing the Camera Head.....	34
9.4	Removing and Installing the MX Spring Assembly.....	35
10.	Camera Skids.....	36
10.1	Camera Skids.....	36
10.2	Skid Installations.....	36
10.2.1	Standard Skid Installation.....	36



10.2.2	Guide Skid Installation.....	37
10.2.3	Removable Rubber Guard Skids.....	38
11.	Locating the Camera Sonde and Pushrod.....	39
11.1	Introduction.....	39
11.2	Applying a Locate Signal onto the Pushrod.....	39
11.3	vLoc3-Cam Sonde and Camera Locator.....	40
11.4	VM-540 Sonde and Camera Locator.....	42
12.	Accessories.....	46
12.1	Skid Range.....	46
12.2	Accessories.....	46
12.3	Camera and Sonde Locators.....	46
13.	Troubleshooting.....	47



1. General Safety Instructions

1.1 Health and Safety

This equipment is primarily used for the inspection of sewer pipes, by professionals operating in the sewer and plumbing industry, and maintained by professionals familiar with the health risks of maintaining equipment that has been in a sewer.

Such professionals will be protected by their own company's recommendations and work practices. If for any reason they are not, or are not familiar with such practices, please check our website or email sales@vxmt.com for a copy of the Health and Safety Document used by Vivax-Metrotech for employees involved in the demonstration, maintenance and handling of sewer camera systems.

- Keep all electrical connections dry and off the ground.
- Be aware of your surroundings at all times. Cone off open manholes and follow traffic control regulations.
- Use personal protection such as eyewear, rubber gloves and non-skid safety shoes.
- **Do not** use the control module as a handle to move the reel. Remove the control module or use the steel handle that is part of the reel's frame.

1.2 Worksite Safety

- Use your company's, or other applicable safety code and rules when using this equipment.
- **Do not** use this equipment in explosive areas – such as in the presence of flammable liquids, gases, and heavy dust.

1.3 Equipment Safety

- **Do not** open the enclosures (housings) of the control module or camera heads.
- Opening the housings or the control module or camera head will void any warranty.
- Use only the leads supplied with the control module for AC or DC operation and charging.

1.4 Batteries and the Environment

Vivax-Metrotech products use four types of batteries:

- Alkaline batteries
- Ni-MH (Nickel Metal Hydride) – rechargeable
- Lithium Ion batteries – rechargeable
- Lithium metal batteries – (small non-rechargeable button cells for “clock” applications)

1.4.1 Alkaline Batteries (Sondes, Light Kits or Locators)

- When replacing the alkaline batteries – use only the size and type specified – **do not** mix battery types (rechargeable and alkaline).
- **Do not** mix partially discharged and fully charged cells in the same battery pack – **do not** mix old with new.
- Never attempt to charge alkaline batteries.

2. Service & Support

2.1 Model and Serial Number Location

Always quote your camera system's model number, serial number and software revision number when requesting product support.

2.1.1 Control Module and Reel Serial Number Location

The control module assembly consists of two major parts. They are the LCD assembly and the control box assembly. The serial number for the vCamMX-2 control module is found on the back of the control box.



1	The control module's serial number label is on the back of the black control box.
2	Type-MX Reel serial number.

2.1.2 Camera Head Serial Number Location

The serial numbers for all camera heads are etched into the camera base across the length of the camera or in the recessed area of the camera housing. The camera skid must be removed to view the serial number of the camera head.

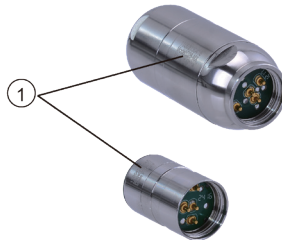

1	MX Series serial numbers
---	--------------------------



2.2 Firmware Revision Location

The "System" screen found in the setup menu shows the control module's firmware (software) version and release date.

The vCamMX-2 series firmware updates come in the form of an "mxip" extension file. The firmware files can be obtained at www.vivax-metrotech.com, authorized service center, distributor or a local Vivax-Metrotech office.

2 Service & Support

To view the control modules current firmware version, follow these steps:

1. Press the “**Setup**”  key to bring up the sub-menu.
2. Press the “**System**”  key to enter the system sub-menu.

The firmware revision is shown on the top line on the left side of the word “Version”.



2.3 Request for Service

In the event that any of the system components need servicing the more concise information provided will result in a quicker turnaround time. On our website you can fill out a “Service Center Request” form, print it and include it with the unit when shipping. If the unit must be returned, package it well and ship by a traceable method.

2.4 Distributors and Service Centers

World Headquarters, United State of America	Central/South America and the Caribbean
<p>Vivax-Metrotech Corporation 3251 Olcott Street, Santa Clara, CA 95054, USA Website : www.vivax-metrotech.com</p> <p>Sales & Sales Support: T/Free : 800-446-3392 Tel : +1-408-734-1400 Fax : +1-408-734-1415 Email : sales@vxmt.com</p> <p>Service & Repairs: T/Free : 800-638-7682 Tel : +1-408-962-9990 Fax : +1-408-734-1799 Email : service@vxmt.com</p>	<p>Ventas para América Latina 3251 Olcott Street, Santa Clara, CA 95054, USA</p> <p>T/Free : 800-624-6210 Tel : +1-408-734-1400 Fax : +1-408-743-5597 Website : www.vivax-metrotech.com Email : VentasparaAmericaLatina@vxmt.com</p>
	China
	<p>Leidi Utility Supply (Shanghai) Ltd. No. 780, Tianshan Rd, Shanghai, China 200051</p> <p>T/Free : 4008-206-719 Tel : +86-21-5235-3001 Fax : +86-21-5235-8365 Website : www.leidi.cn Email : info@leidi.cn</p>
	France
	<p>Vivax-Metrotech SAS Technoparc - 1 allée du Moulin Berger, 69130 Ecully, France</p> <p>Tel : +33(0)4 72 53 03 03 Fax : +33(0)4 72 53 03 13 Website : www.vivax-metrotech.com Email : salesfrance@vxmt.com</p>
	United Kingdom
	<p>Vivax-Metrotech Ltd. Unit 18-19, Woodside Road, South Marston Industrial Estate, Swindon, SN3 4WA, UK</p> <p>Free Phone : 0800 0281811 Tel : +44(0)1793 822679 Website : www.vivax-metrotech.com Email : salesUK@vxmt.com</p>
Australasia	
<p>Vivax-Metrotech AUS Unit 1, 176 South Creek Road, Cromer NSW 2099, Australia</p> <p>Tel : +61-2-9972-9244 Fax : +61-2-9972-9433 Website : www.vivax-metrotechaus.com Email : sales@vxmtaus.com service@vxmtaus.com</p>	
Canada	
<p>Vivax Canada Inc. 41 Courtland Ave Unit 6, Vaughan, ON L4K 3T3, Canada</p> <p>Tel : +1-289-846-3010 Fax : +1-905-752-0214 Website : www.vivax-metrotech.com Email : CanadianSales@vxmt.com</p>	
Germany	
<p>Metrotech Vertriebs GmbH Am steinernen Kreuz 10a D-96110 Schesslitz</p> <p>Tel : +49 954 277 227 43 Email : serviceGermany@vxmt.com</p>	

3. Introduction

3.1 The vCamMX-2 Inspection Camera System

The vCamMX-2 Inspection Systems consist of three major components: vCamMX-2 Control Module, Type-MX Reel with Pushrods, and Camera Heads.

3.2 What's in the box



1	vCamMX-2 Control Module	10	SD Card
2	Type-MX Reel with pushrod	11	USB Thumb drive
3	MX Interconnect cable with covers	12	CD with manuals
4	MX Spring assembly	13	Tool Bag with strap, empty
5	Tool Bag with accessories (Numbers 6, 7, 8, 9, 10, 11, 12, 13, 14, 16 and 17)	14	Pipe insert sleeve
		15	D18-MX Camera Head
6	DC Power Lead	15A	D18-MX Standard Skid
7	Charger with power cable	16	User Handbook
8	Flat blade screwdriver	17	D26-MX Camera Head
9	Fuse	17A	D26-MX Standard Skid

3.3 vCamMX-2 Series Control Module Overview

The vCamMX-2 control modules allows for the viewing, recording and playback of Audio Video Interleave (AVI) format video as well as image capturing of Joint Photographic Experts Group (JPEG) pictures. Audio and text commentary can be added to the videos and text commentary can be added to the captured pictures.

The time stamping of current time, date and distance of pushrod deployed can be added to both video and pictures.

The following describes the features of the control module:

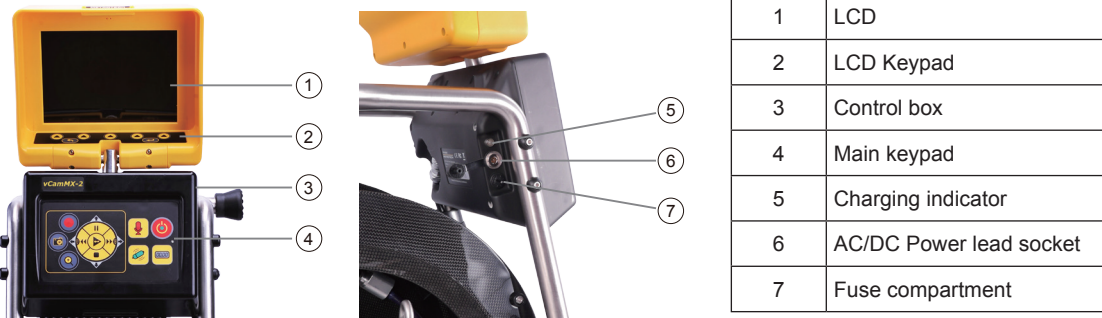

Control Module Front View

Control Module Side View





1	LCD
2	LCD Keypad
3	Control box
4	Main keypad
5	Charging indicator
6	AC/DC Power lead socket
7	Fuse compartment

LCD Keypad Buttons

	Press this key to go back to the previous screen or to exit an operation.
	Press these keys to make a selection while in various menus.
	Press this key when required to complete an action. Press this key to hide and show the main on-screen menu while viewing and recording.

Control Box Buttons

	Press and release to turn the unit on. When on, this button will glow green. Press and hold to turn the unit off.
	Pressing this button will reset the distance counter to zero. A message will momentarily appear on the top screen confirming that the counter has been reset.
	Press this button to turn the internal microphone on and off. When on, the button will glow red and the microphone icon will be shown in the status bar. Stand between one and three feet/1m of the screen and speak facing the screen. The internal microphone is located top center above the screen.
	Pressing this button will activate and de-activate the sonde. With each press of the button the sonde frequency will change. After cycling through the frequencies, the sonde will turn off. When active, the button will glow green and the sonde frequency will appear in the status bar.

 <p>Record</p>	<p>Press this button to start a recording. When active the button will glow red and the record icon will appear in the status bar. Press this button again to end the recording.</p>
 <p>Picture</p>	<p>Press this button to take a JPEG picture. When pressed a message will appear top center screen to confirm that the picture capture was successful.</p>
 <p>Zoom</p>	<p>Press this button to enter the digital zoom mode. One press will zoom x 2, press again to zoom x 3, and press again to exit the zoom mode. The level of zoom will be shown in the status bar.</p>
 <p>Playback controls and Camera lights</p>	<p>While viewing or recording: Use the Left/Right Arrow section to increase or lower the camera lights. Use the Pause/Resume button while recording or playing a video to pause and resume the video. To re-name a file: Use these buttons to navigate the on-screen keyboard which appears when a recording is stopped. Use the center Enter button to select the letters to name the file. While playing a video: Use these buttons to Pause, Forward Fast, Stop and Rewind the video playing.</p>

vCamMX-2 Playback Controls, Camera Lights and On-screen Keyboard

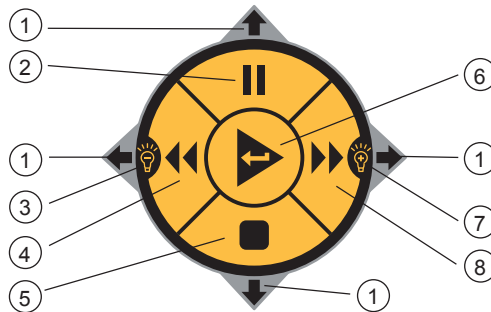

1	Keyboard Navigation	While the file rename dialog box is on the screen, use the buttons corresponding to the top, right, bottom and left arrows to navigate through the on-screen keyboard. Navigate to and press the next key on the on-screen keyboard to save the changes.
2	Pause and Resume	Use this button while recording or playing a video to pause and resume the video.
3	Lower Camera Lights	Lower the camera lights while viewing or recording.
4	Rewind	Rewind the video during playback.
5	Stop	Stop the recording or playing video.
6	Enter Button	Press while in File Manager to play a selected video.
7	Raise Camera Lights	Increase or lower the camera lights while viewing or recording.
8	Fast Forward	Fast forward through the playing video.

3.4 Type-MX Cable Reel Overview

The Type-MX cable reels is used to store and control the deployment of the pushrod cable.

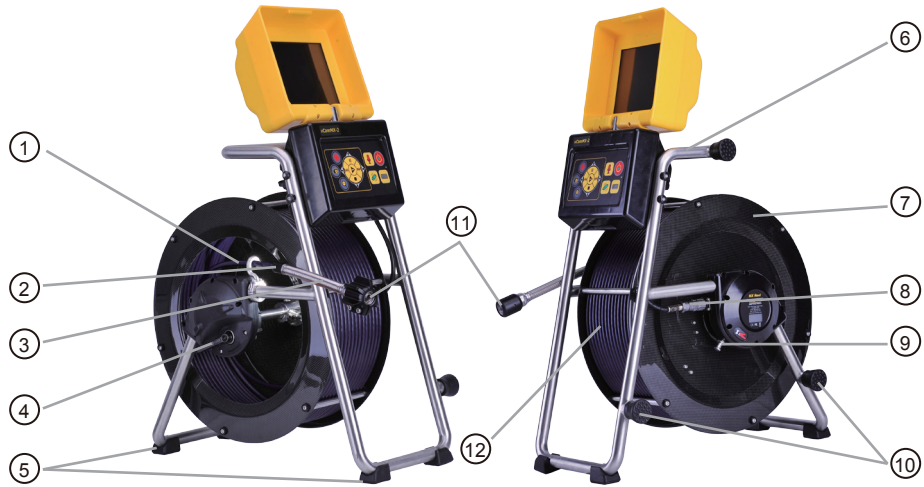

1	Cable guide	7	Cable drum
2	Sonde	8	Pushrod Reel Connection Hub
3	Termination spring	9	Interconnect Cable Socket
4	Friction and locking brake	10	Horizontal Position Feet
5	Rubber feet	11	Camera head
6	Frame	12	Pushrod

4. Initial Control Module Setup

4.1 Initial Control Module Setup

4.1.1 Installing the Fuse

Install the 10 Amp - 250 Volt fuse in the fuse compartment on the side of the control module. The control module will operate without a fuse when using AC power but the battery will not charge and the unit will turn off when the AC power is removed.

The fuse holder is located at the left-side of the control module. Two 10 Amp 250 Volt fuses are included in the control module accessory bag, one for the unit and one spare.

1. Use a screwdriver to unscrew and remove the fuse holder cap. Be sure to use the correct size screwdriver to prevent breaking the fuse holder slot.



2. Insert the 10 Amp 250 Volt fuse into the fuse holder cap.



3. Screw the fuse holder cap with fuse into the control module by hand as far as possible then use a screwdriver to tighten.



4.1.2 Charging the Internal Battery

Plug the supplied battery charger into the control modules AC/DC charging socket. The charging icon on the left side panel will glow red while charging and glow green when fully charged. The typical charging time to fully charge a completely discharged battery will be approximately five hours and provide approximately seven hours of intermittent use.

4 Initial Control Module Setup



4.1.3 About Control Module Settings

After the initial setup of the vCamMX-2 control module is done all the settings selected are saved into the control module's memory and will remain until changed. Note that the settings will be lost if the unit is reset to factory defaults.

The initial control module will set metric or imperial distance measurement, date and time formats, sonde frequencies, language and file renaming options.

4.2 Navigating through the Setup Menu

4.2.1 Key used in the setup procedure

 Step Back / ESC	Press this key to go back to the previous screen or to exit an operation.
 Karat choice keys	Press these keys to make a selection while in various menus.
 Enter	Press this key when required to complete an action. Press this key to hide and show the main menu bar while viewing and recording.

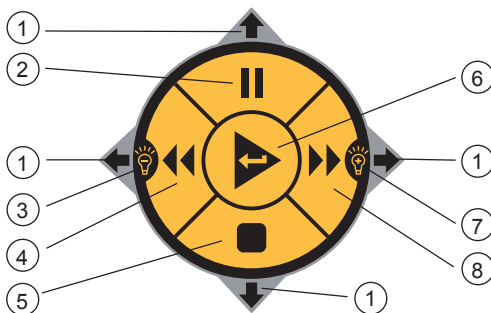





1	Move left	Press this key to move to the left
2	Move right	Press this key to move to the right
3	Move up	Press this key to move up
4	Move down	Press this key to move down
5	Enter	Press this key to confirm selections

4.2.1.1 Turn on the system

Press and release the Power button  on the control module. The button will glow green and the operating system will boot up. Turn off the system by pressing and holding the power button.







4.2.1.2 Set the Language

1. Press the **Setup**  key to enter the setup sub-menu.
2. Press the **Region**  key to enter the setup screen.
3. Use the **Up/Down Scroll**   Keys to highlight the desired language.
4. Press the **Enter**  key to select the language. The updating dialog message will appear and remain until the language change is completed. When completed the system will return to the main viewing screen.

4.2.1.3 Set the Distance Counter Units

The distance of pushrod deployed will be shown on the main screen, center screen between the time and date. The distance measurement will appear in videos and pictures when this feature is active.

4 Initial Control Module Setup







1. Press the **Setup**  key to bring up the sub-menu.
2. Press the **Region**  key to enter the regional sub-menu.
3. Use the **Right Scroll**  key to navigate to the **Measurement** choice list.
4. Use the **Up/Down Scroll**  key to highlight **Meters or Feet**.
5. Press the **Enter**  key to complete the selection.
6. Press the **ESC**  key to return to the setup sub-menu, press again to return to the main viewing screen.

4.2.1.4 Set the Date and Time

Setting the Date/Time format allows the choice of three date formats and the choice of a 12 or 24-hour time format.

Date formats available are: **MM/DD/YYYY**, **DD/MM/YYYY** and **YYYY/MM/DD**

Time formats available are: **12-hour (08:00PM)** or **24 hour (20:00)**

1. Press the **Setup**  key to bring up the sub-menu.
2. Press the **Region**  key to enter the Regional sub-menu.
3. Use the **Right Scroll**  key to navigate to the **Time Format** choice list.
4. Use the **Up/Down Scroll**  keys to highlight the **Date/Time Format** to use.
5. Press the **Enter**  key to complete the selection.
6. Press the **ESC**  key to return to the setup sub-menu, press again to return to the main viewing screen.





4.2.1.5 Set the Storage Options

The default drive for the vCamMX-2 is USB. If no USB drive is inserted the system will record to the SD drive. If neither SD nor USB is present the system will not record.

SD Backup – When the SD Backup option is active the SD card will automatically backup the USB drive.

Any pictures or videos created on the USB drive will automatically be copied onto the SD card. This allows the SD card to be used as a solid state hard drive keeping copies of the files.









To activate the **SD Backup** option:

1. Press the **Setup**  key to bring up the setup sub-menu.
2. Press the **Storage**  key.
3. Press the key corresponding to **SD Card Backup**.
4. The USB with SD backup onscreen switch will change from **white (off)** to **yellow (on)**. USB with SD backup 
5. Press the **ESC**  key to return to the setup sub-menu, press again to return to the main viewing screen.

4.2.1.6 Set the Sonde Frequency



The vCamMX-2 contains a choice of three sonde frequencies. The user can activate any number of the three frequencies or turn off all three. The system has two low frequencies of 512Hz and 640Hz and one high frequency of 33 kHz.

To activate and select the frequencies:

1. Press the **Setup**  key to bring up the sub-menu.
2. Press the **Features**  key to enter the features sub-menu.
3. Press the key corresponding to the **desired sonde frequency** to use. When the key is pressed it will change the choice from **white (off)** to **yellow (on)**.     
4. Press the **ESC**  key to return to the setup sub-menu, press again to return to the main viewing screen.

4.2.1.7 Set the OSD (On Screen Display) Options

The OSD can be set to appear at the bottom or top of the screen or can be turned off. While active, the OSD information will appear in all recorded videos and JPEG pictures.

1. Press the **Setup**  key to bring up the sub-menu.
2. Press the **Features**  key to enter the features sub-menu.

4 Initial Control Module Setup

3. Press the key corresponding to the **OSD**. When the key is pressed it will change the choice from **white (off) to yellow (on)**.



4. Press the **ESC** key to return to the setup sub-menu, press again to return to the main viewing screen.

4.2.1.8 Set the File Rename Option

With the File Rename option the system can be set to use the system default naming scheme of MMDD_HRMMSS (month, day, hour, minute, seconds) or prompt to manually name the file.

1. Press the **Setup** key to bring up the sub-menu.
2. Press the **Features** key to enter the features sub-menu.
3. Press the key corresponding to **Rename** to bring up the rename sub-menu.
4. Select the choices of on or off for renaming either the video files or picture files.
5. Press the key corresponding to **Video or Pictures**. When the key is pressed it will change the choice from **white (off) to yellow (on)**.
6. Press the **ESC** key to return to the Setup sub-menu, press again to return to the main viewing screen.



4.2.1.9 Set up Wi-fi

The built in Wi-fi option allows the vCamMX-2 to connect to smartphones and tablets. A free app for the vCamMX-2 is available for download from the Apple Store.

1. Press the **Setup** key to bring up the sub-menu.
2. Press the **Features** key to enter the features sub-menu.
3. Press the key corresponding to **Wi-fi** to bring up the Wi-fi sub-menu.
4. Press the **ESC** key to return to the setup sub-menu, press again to return to the main viewing screen.

4.2.2 Wi-Fi Administration

The built in Wi-fi option allows the vCamMX-2 to connect to a devices such as smartphones and tablets. The control module will broadcast a SSID which will be seen as a wireless network to connect to. No password is required.

By default the SSID will be "vCamMX2" followed by the last six digits of the control modules serial number. I.e. "vCamMX2-123456".

The Wi-Fi administration sets the SSID for the control module's Wi-Fi.

1. Press the **Setup** key to bring up the sub-menu.
2. Press the **Features** key to enter the features sub-menu.
3. Press the key corresponding to **Wi-fi** to bring up the Wi-fi sub-menu.
4. Press the **ESC** key to return to the setup sub-menu, press again to return to the main viewing screen.

4.2.3 Restore the Factory Default Settings

Restoring the default settings will erase all the settings on the control module and return it to the factory default. This will not erase any videos or images on the hard drive.

1. Press the **Setup** key to bring up the sub-menu.
2. Press the **System** key to enter the System sub-menu.
3. Press the **Reset** key.
4. Confirm that the system should be restored to factory default settings.
5. Select the Check key to start the operation or X key to cancel.
6. Press the **ESC** key to return to the setup sub-menu, press again to return to the main viewing screen.

4.2.4 Update the Control Module Firmware

The vCamMX-2 series firmware updates come in the form of an “.mxip” extension file. The firmware files can be obtained at www.vivax-metrotech.com, authorized service center, distributor or a local Vivax-Metrotech office. **Only USB devices** can be used to perform the update.

The firmware update file must be installed on the USB devices “**root directory**”. Specifically, the files must be visible when viewing the contents of the USB device.



WARNING

**Do not interrupt the update once it has started.
Update the firmware with the control module while running under AC power.**



TIP

Make a note of the control module’s current software version before running the update. When the update is completed you can compare the before and after versions.

1. Copy the firmware update file onto a USB device.
2. Plug the USB device into the control module and turn it on.

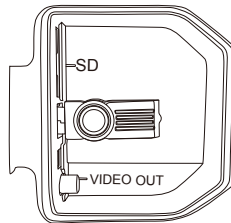

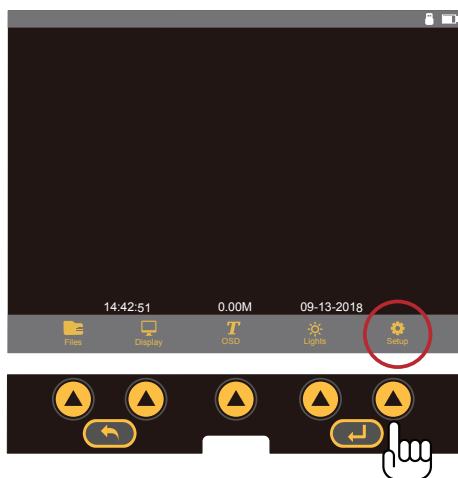

3. Press the “**Setup**” key to bring up the sub-menu. 

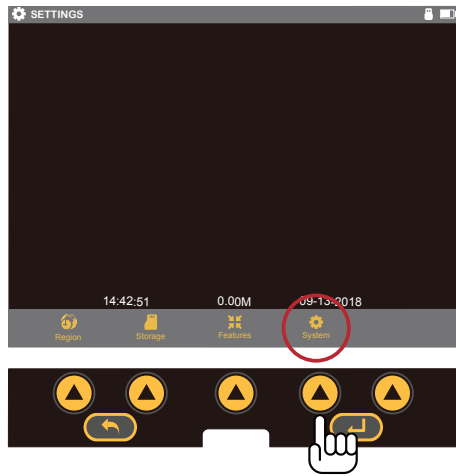

4 Initial Control Module Setup

4. Press the **"System"** key to enter the system sub-menu. 



5. Use the **"Up/Down"** scroll   keys to highlight the firmware update file. Make a note of the current firmware version in the control module. It is shown to the right of the word "Version".

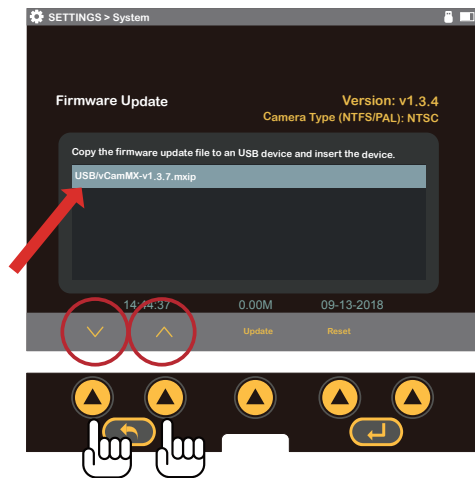

6. Press the **on-screen "Update"** key to  start the firmware update.



4 Initial Control Module Setup

- Let the update **run un-interrupted** until finished. During the update the control module will **(7a)** load the files from the USB device, **(7b)** update the firmware chip in the control module, **(7c)** restart, **(7d)** finish updating the firmware files then restart and return to the main viewing screen.

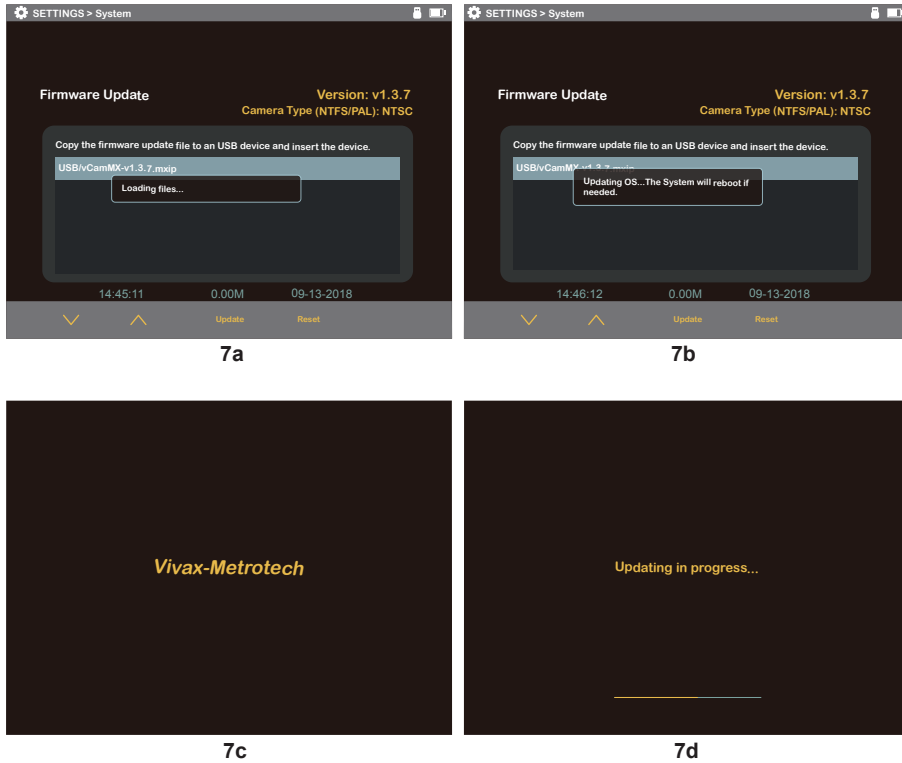

- During the update the control module will reboot twice. Watch the progress indicators and let the system run until it returns to the main viewing screen. **(7e)**

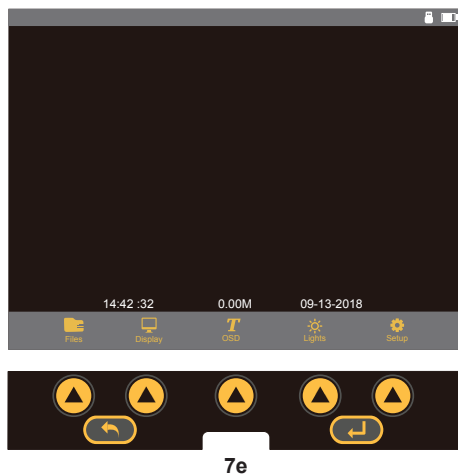

- Confirm the firmware update was successful by comparing the firmware version after the update to the version number before the update. See step 5.

5. Video Recording and Image Capture

5.1 Overview

This section of the manual covers video recording, capturing images, reviewing videos and pictures, and copying, moving and deleting video and picture files.

During a video recording the following options are operational and usable:

- Wi-Fi
- Sonde
- Microphones
- On-screen Text writer
- Camera LED control
- Distance counter reset
- Display color adjustments
- Take a JPEG image picture
- Pause the video for up to 30 minutes
- Use the digital zoom to view close up (view only, the zoom effect will not be recorded)
- Pushrod tracing (some interference may occur on the LCD)

5.2 Recording a video and capturing JPEG pictures

Creating a video recording



Press this button to start a recording. The button will glow red and the record icon will appear in the status bar while recording. Press this button to stop the recording.

Capture a JPEG image



Press this button to take a JPEG picture. When pressed a message will appear top center screen to confirm that the picture capture was successful.



TIP

Use the Text Writer feature to add identifying text to the recording video and image captures. Now while looking at the preview in the file list sub-menu the text recorded on the video and pictures will help identify the target video or picture.

5.3 Viewing Recorded Videos and Pictures in the Control Module

5.3.1 vCamMX-2 File Manager Overview

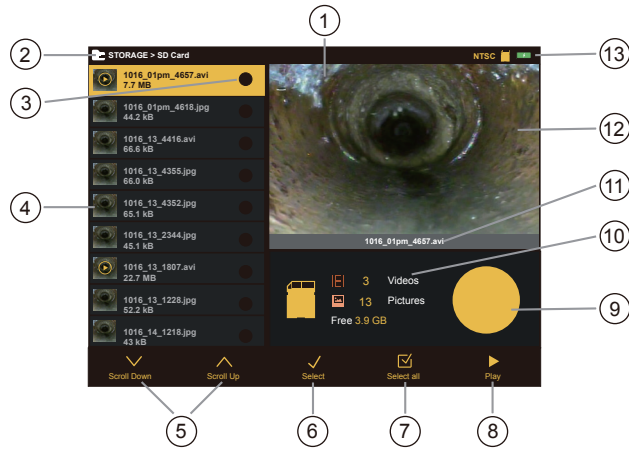

1	Status bar	8	Play key (Delete keys*)
2	Menu and sub-menu location	9	Graph showing the used and free space remaining of the USB drive or SD card
3	File(s) select status		
4	File list	10	SD Card/USB drive information
5	Scroll keys	11	Active file name
6	Select file(s) key	12	Preview window
7	Select all files key (Copy keys*)	13	Status bar

*When more than one file is selected the Select All and Play keys are replaced by Copy and Delete keys.

5.3.2 Viewing and playing contents of the USB drive or SD Card

1. Press the File Manager key to enter the file manager.
2. Choose the drive where the file is located, SD or USB.
3. Use the Up/Down Scroll keys to highlight the desired file.
4. Play - Press the Play key to play the file.

5.3.3 Copying files

1. Press the **Files** key to enter the file manager.
2. Choose the drive where the file is located, **SD** or **USB**.
3. Use the **Up/Down Scroll** keys to highlight the desired file(s).
4. Press the **Select** key to individual files or press **Select All** to select all of the files.
5. Select **Copy** to copy the selected file(s).
Select the copy destination, SD or USB.

5.3.4 Deleting files

1. Follow steps 1 through 4 in section 5.3.3 Copying Files.
2. Press the **Delete** key to delete the file(s). 



WARNING

Do not remove the SD or USB device from the control module while copying or moving files to them. This may result in corrupt un-playable files being created and a risk of corrupting the original file on the hard drive.



NOTE

Only videos or pictures that were originally created in the control module will appear in the file list sub-menu and be viewed on the control module.

5.4 Troubleshooting Video Playback

If a file is copied or moved from the control module and will not play on a PC:

- Check to see if the file will play in the control module. If it will not play then the file may have been corrupted during the move or copy. Try and recopy the file again making sure not to interrupt the process until it is completely finished.

If a file copied or moved from the control module, will play in the control module but not play on a PC:

- Try a different media player on the PC and try a different PC. The AVI video format used by the control module is a Microsoft format and should play in the Windows Media Player with no issues. If the file is not playing or playing incorrectly there is a possibility that the correct video codec is missing. Computers running Windows 8 or higher will most likely have this codec installed by default. It is possible that in older operating systems a codec may need to be installed. See section 5.8 Getting Codecs.

5.5 AVI Video Format

Audio Video Interleaved (aka Audio Video Interleave), known by its initials and file extension of .avi, is a multimedia container format introduced by Microsoft in 1992. AVI files can contain both audio and video data in a file container that allows synchronous audio-with-video playback. Because this file format was developed by Microsoft; the AVI video format will play in Microsoft's Windows Media Player as well as other media players.

5.6 Getting Codecs

If an AVI video file will not play or plays as an audio file with video, it may be because you do not have the appropriate codecs installed on your computer. The video and audio tracks in a file have been "encoded" or "coded", and must be "decoded" in the right way in order to play the file back. This is why a codec is needed (**C**oder / **D**ecoder). A media player, such as **WMP (Windows Media Player)** may require a specific codecs to be installed in order to play a specific type of video file.

When videos are transferred from the control module to a SD or USB device, a compressed folder is added to the SD or USB device containing software named "MediaPlayPlus". Installing MediaPlayPlus to your Windows PC will add new features to Windows Media Player and add the codecs which are necessary to play the AVI file. Specific AVI codecs can also be downloaded from the DivX website at www.divx.com. When installing the DivX program it is recommended to choose "Custom Install" so that only the necessary components are installed.

5.7 File Associations

To make a certain type of file extension run with a default program each time a file association needs to be set in the windows operating system.

1. In "My Computer" or "File Explorer", right mouse click on an AVI file.
2. Select "open with".

5 Video Recording and Image Capture

3. Select Windows Media Player. If Windows Media Player is not shown on the list of available software, you will have to select “Choose Default Program” in the bottom right corner. Select “Windows Media Player” here.

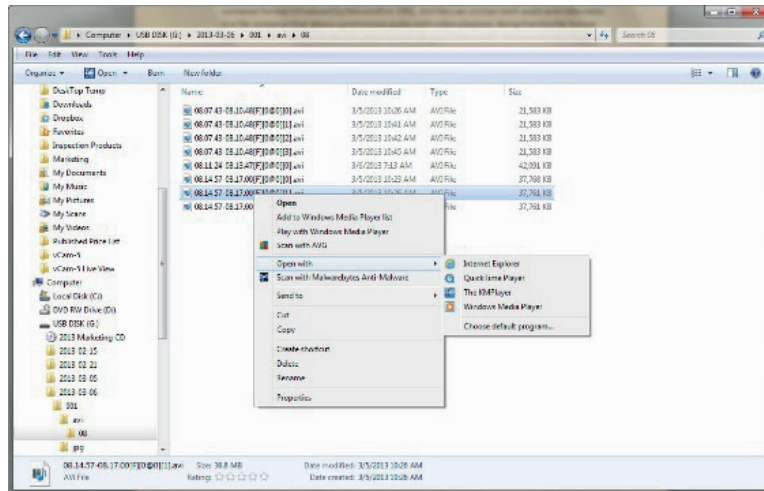

4. Make sure the “Always use the selected program to open this kind of file” box is checked. If “Windows Media Player” is not shown in the “Choose Default Program” choices then you will have to use the “browse” function to manually add the programs “executable” (.exe) file in “C:\Program Files”. This option requires an advanced knowledge of the Windows operating system.

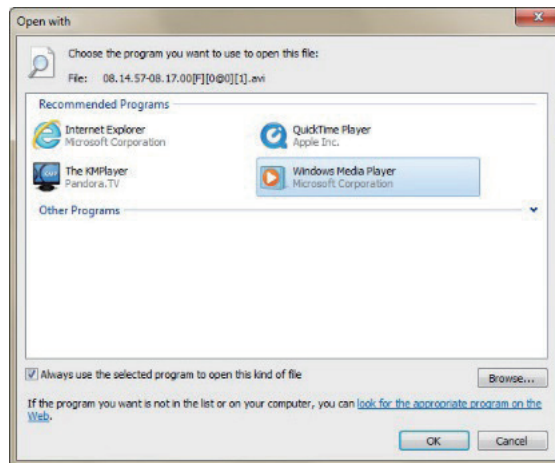

5. Consult your IT department or computer dealer if needed.

5.8 Other Media Players

There are several free video players available for download on the internet. These video players allow some advanced features that Windows Media Player may not have, such as playing several videos at the same time to compare them, and the ability to play multiple video formats. You can find these by doing an internet Search on “Video Players” or “AVI Video Players”.

A few of the more popular players are:

- The KM Player <http://www.kmpmedia.net/>
- VLC Player <http://www.videolan.org/>
- DivX Player <http://www.divx.com/>



NOTE

Vivax-Metrotech does not provide technical support for any of these players or Windows Media Player. Consult the manufacturer or your local IT department for technical support.

Vivax-Metrotech has manufactured the vCam-6 control module to produce video files and jpeg pictures that are compatible with the various Windows operating systems from Windows XP and later versions. Vivax-Metrotech cannot be responsible for the compatibility of all types of SD cards or USB drives. It is highly recommended that before these devices are purchased in bulk that they are tested for compatibility first.

Vivax-Metrotech cannot provide technical support for any of these devices, Windows Media Player, security and multi-media settings on computers.

Consult the manufacturer or your local IT department for technical support on these items.

6. Features Available During Recording

During a video recording the following options are operational and usable:

- Wi-Fi
- Sonde
- Audio Commenting
- On-screen Text writer
- Camera LED control
- Distance counter reset
- Display color adjustments
- Take a JPEG image picture
- Pause the video for up to 30 minutes
- Use the digital zoom to view close up (view only, the zoom effect will not be recorded)
- Pushrod tracing (some interference may occur on the LCD)

6.1 Voice Over

The voice over feature will add audio comments to the recorded video. The control module has an internal microphone located right above the display.





Microphone on/off button



Microphone on, icon shown on the status bar





1. Press the **Microphone** button on the front panel of the control module. When the microphone is on the button will glow red and the microphone icon will be shown on the screens status bar.
2. Speak clearly at a normal tone and volume towards the internal microphone located above the display.
3. Stay at a distance between one to two feet from the internal microphone while speaking.
4. Press the **Microphone** button again to turn the microphone off.

6.2 Volume Control

During playback of recorded video, the volume level can be adjusted. During video playback volume increase  **+** and volume decrease icons  **-** are shown on the bottom left of the display. Use the corresponding keys to increase and decrease the volume.

6.3 Display and Backlight Settings

At any time pressing the **Display option from the LCD keypad** key will bring up the color settings/backlight sub-menu. From this menu the color settings for the LCD can be made and the backlight turned adjusted.

1. Use the **up**  and **down**  arrow keys to move between the color settings selections.
2. Use the **left**  and **right**  arrow keys to lower or raise the display settings.
3. When done with the display adjustments press the ESC key to return to the main on-screen menu.

6.4 On-Screen Status Bar

The status bar shows the battery status and active features such as sonde, microphone and Wi-fi. The status bar is shown in all menus and sub-menus and is located at the top of the display.

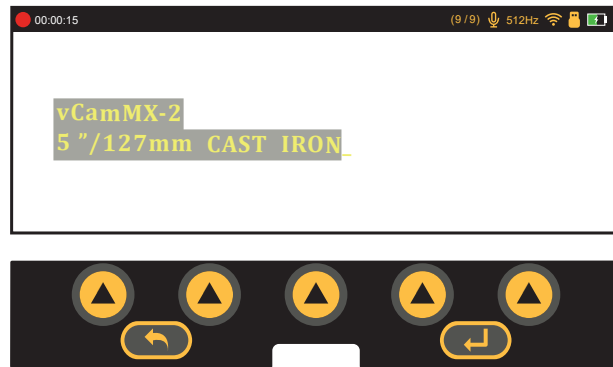

6.5 On-Screen Display (OSD Info)

The current time, date and distance of pushrod deployed can be shown on the screen and can be recorded in videos and pictures. The color of the OSD info can also be changed to suit the environment inside the pipe being inspected. By default the OSD is positioned at the bottom of the screen and in white text.

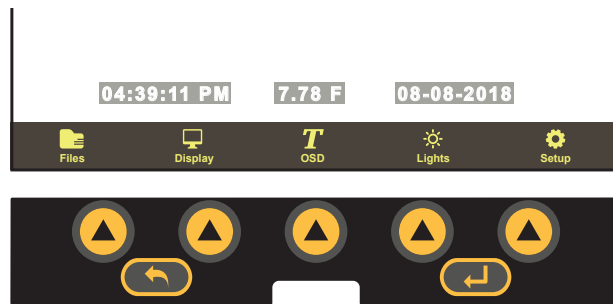

See section 4.2.1.7 in initial setup to set the default position and colors of the OSD.

1. Press the **OSD** key to enter the OSD sub-menu.
2. Press the **Color** key to toggle through the choices of white, green and yellow.
3. Press the **Position** key to toggle the position from bottom to top.
4. Press the **ESC** key to save the changes and return to the main on-screen menu.

6.6 Camera LED Light Control

The LED's on the camera head can be adjusted two ways.

6.6.1 From the Media keypad

Use the left/right keys to lower and raise the camera lighting.

Use the keypad on the control box to raise and lower the camera's LED lighting.

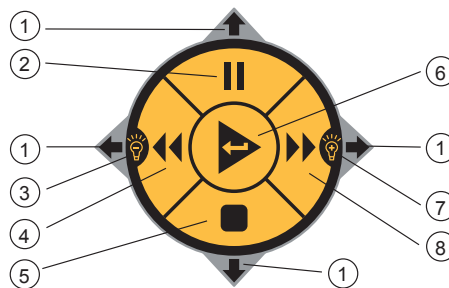

6.6.2 From the LCD Keypad:

1. Press "Lights" to bring up the LED lights sub-menu.

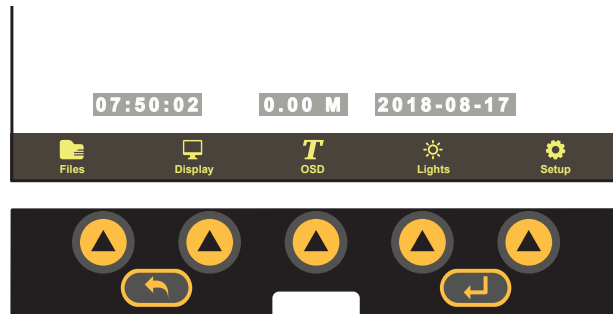

2. Use the corresponding karat keys to raise and lower the camera's LED lighting.



3. Press the ESC key to return to the main on-screen menu.

6.7 On-Screen Text Writer

6.7.1 Introduction to the on-screen Text Writer

The on-screen Text Writer function allows users to add descriptive text and comments which will appear on recorded videos and pictures. The user can customize the text colors being shown on the videos and pictures. The on-screen Text Writer has unlimited pages with 14 lines and 30 characters per line per page to be saved and later recalled for use.

The content from the on-screen Text Writer is saved into memory so if the unit is turned off the text will still be available when turned on again.

Alternatively, a USB keyboard can be used by plugging it into USB port.



NOTE

If the unit is reset to factory defaults the saved pages of text will be lost. If the CMOS battery on the DVR circuit board is removed all text will be lost. Only the text is saved into memory. Any colored text will be reset to the default color of white.

T OSD Sub-menu options

1	OSD (On-Screen Display) – Consists of the system’s time, distance count, and date.
2	Color – Changes the text colors from white to black to yellow to green then back to the default color of white.
3	Position – Moves the time/distance/date from the bottom to the top and then off.
4	ESC – Press to return to previous screen or to exit an operation.
5	Page – Scrolls through saved pages of text.
6	Enter key – Press this key when required to complete an action.
7	Erase – Clears the current screen of all text and deletes the saved page.
8	Keyboard – Brings up the on-screen keyboard.
9	Status bar – Status Bar shows the control module’s running features such as sonde and battery status. The current sub-menu location is also displayed.
10	Current page/Page number – Shows current page first and number of saved pages. (current/saved) New text can be entered on the current page which is identified by the character “-”.
11	On-Screen keyboard – Use the keyboard to add and edit text on the screen.

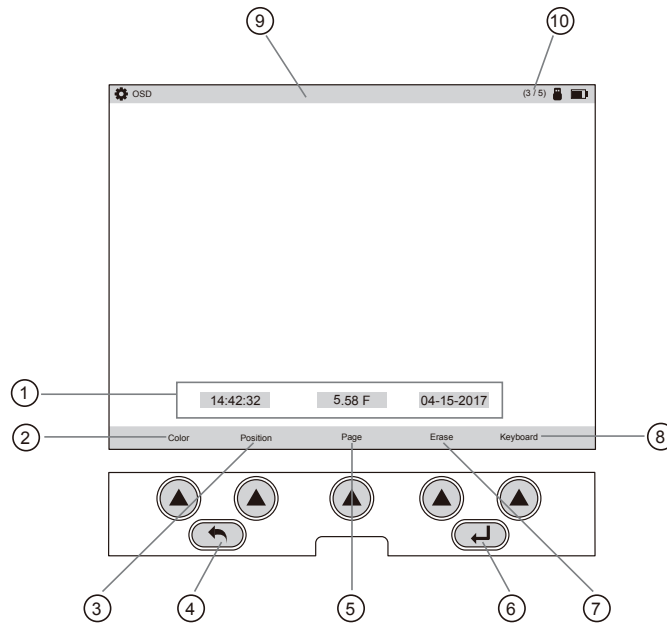

Figure 1

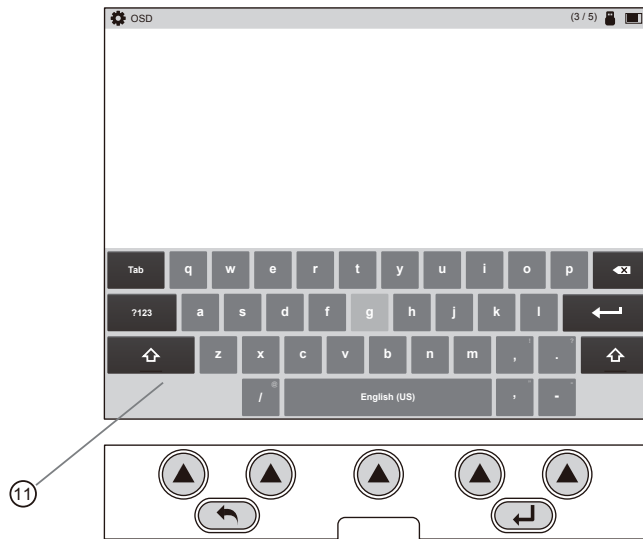
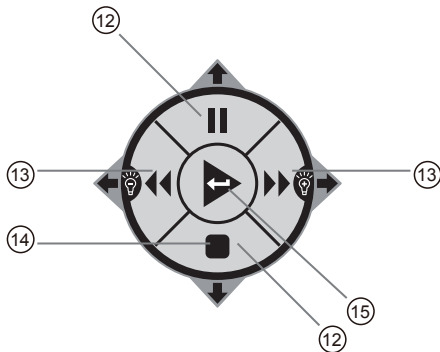

Figure 1a

Navigating the on-screen keyboard



12	Up/Down keys – Use these keys to navigate up and down on the on-screen keyboard.
13	Left/Right – Use these keys to navigate left and right on the on-screen keyboard.
14	Show/Hide – During a recording use this key to hide and show the on-screen text.
15	Enter – Use this key to select characters from the on-screen keyboard.



Tip:
The on-screen keyboard option requires firmware version 1.4.8 or later.

To operate the on-screen keyboard:

1. From the main menu press the “**OSD**” **T** key to enter the OSD sub-menu.
2. Press the “**Keyboard**” key to bring up the on-screen keyboard to the screen.
3. Use the Rewind, Forward, Stop and Pause keys to navigate through the keyboard and use the Enter key (center) to select the text and numeric characters.
4. Press the “**ESC**” key to close the keyboard and return to the sub-menu. Press again to return to the Main Menu.

With the on-screen keyboard, six lines of text with 37 characters per line can be added.

The text from the on-screen keyboard is **automatically saved** as it is entered. If the text that is entered is intended for one-time use, press the “Erase” key before advancing to the next page of text or turning the unit off.

Note: The on-screen keyboard will never appear in any videos or pictures.



Tip:

Use the pause key to pause the video while entering text. When finished entering text press pause again to resume recording.

Use the Stop key to hide and show the current page of text.

Status bar page information:

1. In this figure, the upper right hand corner shows the page status page 2 of 2 pages.
2. The text 2/ shows that the current page being edited is page 2.
3. The text /2 shows that a total of 2 saved pages are in memory.



To erase saved pages of text:

1. Use the “Page” key to scroll through the saved pages of text and stop at the page to be deleted.
2. Press the “Erase” key and a dialog box will appear confirming the current page deletion.
3. Press the “Yes” key to delete the page.
4. Press the “ESC” key to close the keyboard and return to the main menu.



TIP

Darker colors may work better in pipes with water running through them. The lights from the camera head may reflect in the water and white or yellow text may become washed out. Use a darker color and switch from light to dark when needed.



TIP

Use the Pause key on the top keypad to pause the video recording. With the video paused use the up and down arrow keys to scroll through the saved pages of text and stop at the desired page. With the desired text being shown un-pause the video to continue recording. At any time during the recording press the ESC key to clear the text from the screen.

6.8 JPEG Image Capture

1. At any time press the **Picture Capture**  key on the control box.
2. The picture icon and picture file name will appear momentarily center screen confirming that the picture was taken and saved.
3. Pictures can be taken from live video, while a recording is in progress, or from a video being played back in the control module.



TIP

Use the Text Writer feature to add identifying text to the recording video and image captures. Now while looking at the preview in the file list sub-menu the text recorded on the video and pictures will help identify the target video or picture.

6.9 Digital Zoom

Use the zoom feature while viewing live video, recorded video or jpeg captures.

1. Press the **Zoom**  button on the control box to activate the zoom feature.
2. Repeated pressing will increase the zoom level will zoom to x2, x3 and then back to normal.

Note that the zoom feature is for viewing only and will not be seen on recorded video or pictures.

7. Wi-Fi and Ethernet

7.1 *Wi-Fi Connection for Apps*

The vCamMX-2 Control Module has built in Wi-Fi that broadcasts an SSID (secure network name) and uses DHCP (the protocol that assigns an IP address needed to connect to the control module) to assign IP addresses to a tablet or smartphone.

When connected to the control module the smartphone/tablet app can be used to stream live video from the control module. The video stream will include any text from the on-screen text writer.

Visit our website at www.vivax-metrotech.com for more information and download link.

8. Cable Reels

8.1 Using the Cable Reels

8.1.1 Pushrod Cable

The Pushrod Cable is constructed of a fiberglass rod surrounded by wire conductors and a Kevlar braid, all of which are coated with a thick polypropylene jacket. Because of the harsh environment the pushrod is used in, care should be taken to keep it in good operating condition.

Check Pushrod for Wear – Visually inspect the pushrod for cuts, kinks and abrasions as it is retrieved back into the cable cage. If the jacket is cut or worn to the point that the yellow or white Kevlar braid can be seen, then it is time to replace the pushrod. Using the pushrod with open cuts will result in water and moisture entering the pushrod and eventually travelling through it, causing a degraded camera image, or total image failure.

The pushrod shown below is an example of a badly worn jacket. This pushrod should be replaced as soon as possible.



Keep the Pushrod and Termination Spring Assembly dry and clean – When retrieving the pushrod keep a clean dry rag in one hand and wipe down the pushrod as it moves through it. At the end of the day use low pressure water to rinse off the camera head and rinse away accumulated dirt and debris that may be caught in the spring. Shake dry or use low-pressure air to blow the excess water away and dry off the parts. The Camera Head, Pushrod and Termination Parts are exposed to very harsh chemicals in day-to-day use. Keeping a clean system will help prolong the life of these parts.

Maintain proper control of the pushrod – Attempting to pull the pushrod out of the reel while the reel is locked will result in the pushrod collapsing in the reel and stressing the pushrod. Pushing the pushrod back into the reel while it is locked may cause the reel to tip over or kink the cable.

Rinse off the termination parts before the end of the day – The camera and pushrod are subjected to a very harsh environment with possibly very caustic chemicals. If the parts are not cleaned off and allowed to dry after use it may prematurely wear on these parts. Use low-pressure water to rinse out the termination spring parts. Wipe dry or use air to blow off the water before storing for the night or long periods. It is a good practice to remove the skid when storing to prevent water from drying between the skid and camera head.

8.1.2 Using the Cable Reel

The vCamMX-2 system comes as a complete system with control module attached or with just the Type-MX reel only and used with other vCam series control modules. When the unit ships as a reel only, an interconnect cable which plugs into other vCam series control modules is provided.

Insertion Sleeve – The Insertion Sleeve is inserted into the mouth of pipe to prevent the pushrod from making direct contact with the pipe when deploying. This prevents chafing of the pushrod jacket and the end result will be prolonged life of the pushrod.



Insert Sleeve

8.1.3 Deployment of the Pushrod Cable



WARNING

The friction brake should always be partially applied to slow down cable deployment. To avoid injury, great care should be taken when stopping the cable from unwinding.

Do not wear loose clothing that can become caught in a spinning reel. Keep hands away from a spinning reel.

1. Position the reel on a flat surface approximately 3 to 4 feet or 1 to 1-1/2 meters from the entry point. This will provide enough space to work with the pushrod without a lot of slack dragging on the ground. Use the friction brake to slow down the movement of the cable cage if needed. Using the reel in a horizontal position makes the width between the feet greater. This will give the reel more stability if on uneven surfaces and will lower the height when in confined spaces.
2. Unlock the cable cage and spin the cage forward (clockwise) so that the camera head is at the 9 O'clock position.

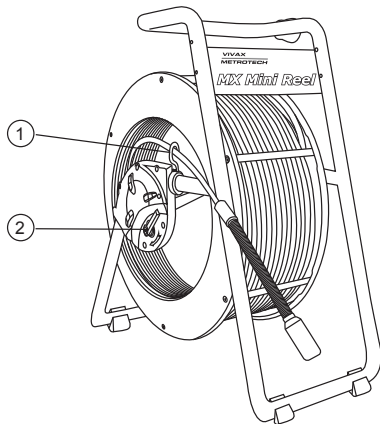

MX Mini Reel

1	Cable Guide
2	Locking Brake and Friction Brake

3. Turn the cable cage forward (clockwise) until the camera head is approximately at 9 o'clock position.
4. Pull the termination spring out of the cage and enough of the pushrod through the cage opening to thread the pushrod into the cable guide.
5. The reel is now ready to be deployed into the pipe.



TIP

Before deploying the pushrod you should:

- a) Remove any standing water from the pipe. The images will be much better if the camera head is not underwater.
- b) Remove debris and objects from the pipe first. The camera is made to inspect the insides of pipes and not to clean them or unblock them.

8 Cable Reels

Use the Insertion Sleeve as much as possible to prevent the pushrod from rubbing on sharp surfaces. Use devices such as a Tiger Tail when the point of entry makes it impossible to use the Insertion Sleeve such as inspecting lines in a manhole.

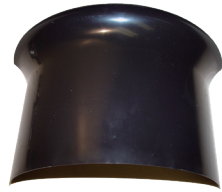

Insert Sleeve



Insert Sleeve in cleanout

Use “grip” type rubber gloves to get a better grasp while pushing and to protect your hands from sludge during retrieval. The gripping action of the gloves will help keep a good hold on the pushrod while deploying.

Apply the pushing force to the pushrod as close to the point of entry as possible. Having excess pushrod between the point of entry and while pushing could result in kinking the pushrod. Never stand to use your weight to push on the pushrod. This may cause the pushrod to kink.



Proper placement and pushing force



Improper placement and pushing may result in kinking the pushrod

Use finesse and not force when needed. The camera and pushrod are made to travel through multiple bends within reason. If having trouble navigating through the pipe try and pull the camera back four to eight inches and give it a quick push through. Sometimes the quick pushing motion will push the camera and termination through a tight area. Never pull the camera head back and repeatedly ram it into the pipe in an attempt to get through.

Run water in the pipe while inspecting. Inspect downstream with water running to lessen the friction in the pipe and to wash away dirt that may collect on the camera lens.

When having difficulties pushing, it may be better to do the recording on the way back, so that the video recording does not waste time showing a navigation through difficult areas. Record during the pull back and use even slow strokes to pull back the pushrod.

When accessing a “T” entry use a string to bend lift the camera head and point it in the desired direction in the T. Be extra careful in T entries not to fold the camera back on itself; this could cause the camera to get stuck in the pipe.

Be sure to use the correct model camera in the correct size pipe. Using a camera that is too big may cause it to get stuck; using a camera that is too small will result in poor lighting and video quality.

8 Cable Reels

Use a skid on the camera head. A skid will not only protect the camera head from directly hitting debris and offsets, it will also keep the camera head off the floor of the pipe and better centered within it. Keeping the camera head off the floor of the pipe will also improve the picture quality, because the light from the camera will be more evenly spread in the pipe. Various types of skids are available for different applications. See the section of this manual which covers accessories or visit our website for more skid information.



With no skid the camera head sits on the floor of the pipe. The camera head comes into contact with silt and debris in the pipe.

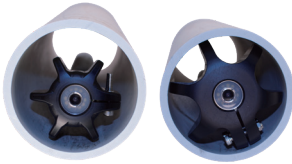

Using a skid lifts the camera head up off of the floor to help avoid silt and debris on the pipe floor.

When retrieving the pushrod take care and try to lay the rod in the cage in layers while wiping the rod free of water and debris.

9. Camera Heads and Terminations

9.1 Parts of the Camera Heads

D18-MX and D26-MX Cameras for MX Mini Reel

Camera Head Face



1	Sapphire glass lens
2	Polycarbonate LED cover

Camera Head Body



1	Groove for skid setscrews
2	Camera housing

Camera Head Rear



1	Interior threads
2	Gold contact pins
3	Circuit board

9.1.1 Camera Head Options

The vCamMX series camera heads are available in two sizes for various applications. Choosing the proper camera depends on the diameter of the pipe to be inspected. The vCamMX Control Module will sense the video format (PAL or NTSC) and automatically reset itself to work in that format.

All camera heads ship with a protective “standard skid” installed.

Camera Head Options for Mini MX Reel

Camera Heads	Fits Reels	Description	Pipe Size Range
 <p>D18-MX Non-Leveling 18mm / 0.76" diameter</p>	MX Mini Reel	D18-MX NTSC (USA) D18-MX PAL (Europe)	2 to 4 inches 50 to 100mm

 <p>D26-MX Self-Leveling 26mm / 1" diameter</p>	<p>MX Mini Reel</p>	<p>D26-MX NTSC (USA) D26-MX PAL (Europe)</p>	<p>2 to 4 inches 50 to 100mm</p>
<p>Contact a local Vivax-Metrotech distributor or local office for ordering information, applications, compatibility and pricing.</p>			

9.2 Spring Termination Parts



The Spring Termination Assembly is comprised of the parts that connect the camera head on one end and are connected to the pushrod on the other. The termination spring assembly for the MX reel is an all-in-one assembly consisting of a spring, coiled cable and lanyard preassembled.

MX Mini Termination Spring Assembly



1	Camera End with Circular Circuit Board
2	Spring Assembly with Coiled Cable and Lanyard
3	Pushrod End with Push Pins

9.2.1 Termination Parts List

Picture	Description	Comments
	<p>Spring assembly O-Ring, 14mm x 1.5mm, NBR</p>	<p>Two required, one at each end.</p>
	<p>MX Spring Assembly</p>	<p>All-in-one assembly consisting of spring, coiled cable and lanyard preassembled</p>

Contact a local Vivax-Metrotech distributor or local office for ordering information, applications, compatibility and pricing.

9.2.2 Pre-checking the Camera Head Before Installing

If the occasion should arise where a camera head must be re-installed or replaced, pre-check these items before the camera is fully installed. The visual checks can be done in an area with good lighting with the use of a magnifier. Some checks are better done with the camera LEDs turned on.

9.2.3 Pre-checking for Picture and LED Control

Visually check the circular connector in the camera base for deep scratches, dirt or corrosion. Attach the camera to a reel and power on the control module. Through the control module check for an acceptable picture, that the LED lights on, the camera work and that you can control the LED lights.

9.2.4 Pre-checking the Camera Glass Lens and LED Cover

This pre-check is better done with a control module attached to a reel or by the camera test port. For this pre-check, the LED lights should be on so that the camera face can be better examined.

Pre-checking the LED Cover

The Polycarbonate LED cover is the section of the face of the camera that covers the LEDs. Visually check the inside and outside radius for chips and cracks.



Sapphire Glass Lens

The Sapphire Glass camera lens is the center clear glass section of the camera face. Visually check the outside radius for chips and cracks. Visually check the surface of the glass for scratches.

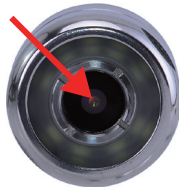



If you suspect that any cracks or chips may let moisture in, or if you suspect that scratches on the lens may affect the video quality, contact the factory or your local dealer.

9.3 Removing and Installing the Camera Head

Try not to touch the green circuit board or gold pins on the spring assembly or camera head with bare hands. Touching these will transfer oils from the fingers to these components which may lead to corrosion. Wear clean rubber gloves if possible.





Camera head removal	
<ol style="list-style-type: none"> 1. Grasp the spring assembly close to the base of the camera head. 	
<ol style="list-style-type: none"> 2. Use the other hand to turn the camera head counter-clockwise. 3. Turn until the camera is removed. 	
Camera head installation	
<p>Note: Remove any excess dirt that might come into contact with the gold pins or green circuit board. Check that the O-ring is in good condition.</p>	

9 Camera Heads and Terminations

<ol style="list-style-type: none"> 1. Hold the termination spring close to the base of the camera head. 2. Present the camera head to the spring. 3. Screw on the camera head by turning it in the clockwise direction. 	
<ol style="list-style-type: none"> 4. Screw on until the O-Ring is no longer visible. <p>Hand tighten the camera head. Do not use any tools to tighten the camera head.</p>	

9.4 Removing and Installing the MX Spring Assembly

Try not to touch the green circuit board or gold pins on the spring assembly or camera head with bare hands. Touching these will transfer oils from the fingers to these components which may lead to corrosion. Wear clean rubber gloves if possible.

<p>Remove the camera head following the instructions shown in section 9.3.</p>	
<ol style="list-style-type: none"> 1. Hold the base of the termination at the sonde end while unscrewing the spring by rotating in a counter-clockwise direction. 	
<ol style="list-style-type: none"> 2. Continue to unscrew the spring by turning it in the counter-clockwise direction. 	
<p>Installing: Remove any excess dirt that might get onto the gold pins or green circuit board. Check that the O-ring is in good condition.</p>	
<ol style="list-style-type: none"> 1. Hold the base of the termination at the sonde end while screwing on the spring in the clockwise direction. 	
<ol style="list-style-type: none"> 2. Continue to screw on the spring until the O-Ring is no longer visible. <p>Hand tighten only. Do not use any tools to install the camera head or spring assembly.</p>	

10. Camera Skids

10.1 Camera Skids

Camera skids are devices that attach to the camera head to 1) keep the camera head off the floor of the pipe, to help avoid pushing up debris and dirt on which will end up on the camera lens blocking your view, 2) allow the camera LED lighting to function better by keeping the lights more centered in the pipe allowing a more even spread of light on the pipe walls and ahead and 3) provide protection to the camera head by giving a shoveling effect which allows the camera head to be lifted over offsets and objects which helps prevent the camera head from making direct contact with them. And lastly the skids will help increase the pushing distance of the camera and pushrod by providing a more non-binding material to slide against plastic, clay, metal and cement pipes. There are a variety of skids for specific uses and camera sizes and few different methods of attaching the skids to the camera system.

The skid installation types are:

- **Standard Skid:** The Standard Skid is supplied attached to a new camera head. Three small slotted screws are used to fasten the skid to the camera housing. A flat screwdriver is supplied in the tool bag.
- **Guide Skid:** Clamp-around skids slide onto the camera head and are then tightened in a clamp type configuration. These skids are referred to as “*Guide Skids*”.

10.2 Skid Installations

There are two different installation methods for camera skids: “setscrews” which tighten into the side of the camera housing and “clamp on” which clamp around the camera housing.

10.2.1 Standard Skid Installation

The standard skids ship installed on the camera head.

Tools Needed: two or three-millimeter hex key or flat screwdriver, depending on skid model.

1. Use the hex key or screwdriver back out the three screws so that the camera head will slide un-obstructed into the skid.



2. Slide the camera head into the skid until the head is flush with the front of the skid.



3. Use a hex key or screwdriver to secure the skid to the camera head.



NOTE

Do not over tighten the setscrews. This may result in stripping the screw threads or damage to the camera housing.



TIP

Apply a layer of electrical tape over the screw holes on the installed skid. This will help keep debris and soil out of the screw slots making it easier to remove.



10.2.2 Guide Skid Installation

Tools Needed: Hex key

1. Use a 140mm hex key and loosen the screws so that the skid will slide un-obstructed onto the camera head.



2. Slide the camera head into the skid until the head is flush with the front of the skid.

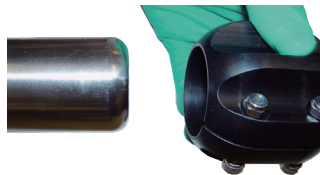

3. Use a hex key to secure the skid to the camera head.





NOTE

Do not over tighten the setscrews. This may result in damage to the camera housing.

10.2.3 Removable Rubber Guard Skids

Some of the vCam series skids will come with a removable rubber front guard. The removable rubber front is meant to protect the camera it should make direct contact with objects such as offsets. Over time the rubber guard will wear and then it can be replaced with a new rubber front guard. Follow these directions to change the rubber front guard.

1. Remove the skid from the camera.



2. With two fingers squeeze the rubber front guard as shown and pull it free of the skid.



3. Follow the same procedure to install a fresh one.

11. Locating the Camera Sonde and Pushrod

11.1 Introduction

The Type-MX reel includes a locatable sonde located at the base of the spring termination assembly. The controls for the sonde are located on the front panel of the control module.

The Type-MX reel includes the option to trace the entire length of pushrod. A utility locator's transmitter is used externally to send a locate signal through the length of the pushrod.

Vivax-Metrotech manufactures a range of utility locators and sonde locators. This manual will give a brief review of how to use the vLoc3-Cam and VM-540 Sonde Locators. Information and instructions on these locators can be found on our website or by contacting your local distributor for more information.

11.2 Applying a Locate Signal onto the Pushrod

A utility locator transmitter is required to locate the pushrod. Frequencies starting at 33kHz and above will work better than lower frequencies.

1. Lock the cable cage by using the brake lock.
2. Connect the red colored hot lead from the transmitter to the contact post on the Type-CP or MX reel. Refer to the diagrams in section 3.4.2 and 3.4.3 for the contact post location for the reels.
3. Place the utility locator transmitter:
 - a) Out of the reel's general work area.
 - b) To prevent the leads of the transmitter from becoming tangled in the spinning reel cage.
 - c) So that the leads from the transmitter are not crossing earth over the path of the pushrod in the pipe.
4. Insert the transmitter's ground stake in earth approximately five feet at a right angle to the reel.



5. Turn on the utility locator transmitter and select a frequency. We recommend using a higher frequency such as, 65kHz or 83kHz. Insure that the transmitter has a good ground. The better the ground the better the locator will perform.
6. Use the utility locator in the line mode, not sonde mode to trace the path of the pushrod underground.



IMPORTANT

Always "Call 811 Before You Dig" and follow your own company's safety practices.
Always follow local, state and national regulations.

Sonde Locating

The best practice for locating the camera sonde is to push the camera into the pipe and when it is level stop and do the locate. From this point on work in 10 to 20 foot increments stopping every 10 to 20 feet and locate the sonde. It is not a good practice to just push the camera into the pipe a great distance away and set out to locate it. The distance counter in the control module may give an estimate as to how far the camera has been deployed but this is just for reference.

11.3 vLoc3-Cam Sonde and Camera Locator

Sonde screen icons:

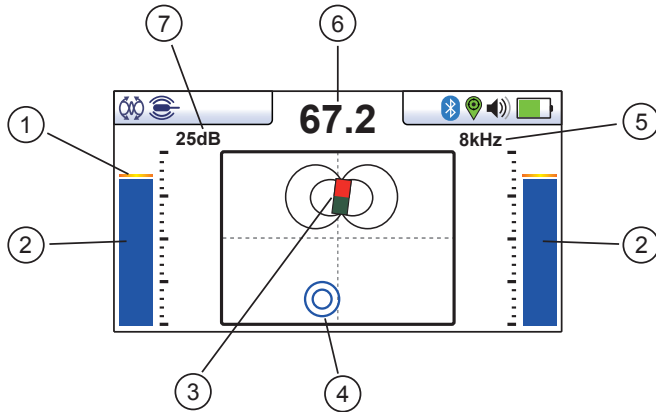

1	Peak signal detector
2	Signal strength bar graph
3	Sonde icon
4	Null point
5	Frequency selection
6	Numeric signal level (mirrors the bar graph)
7	Gain setting

A Sonde is a transmitting coil, the signal radiates in a different manner than that of a line.

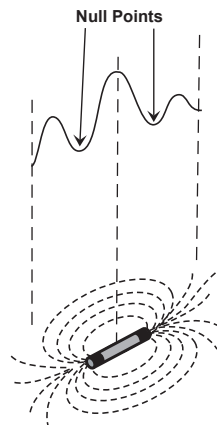

Due to this construction, the sonde gives a different “Peak” pattern note that there are three distinct peaks – a small peak – a large peak – a small peak with two “Nulls” between the peaks. The sonde is located under the center of the “large peak”.

The vLoc3 series receivers detects the presence of the two “Null” signals and also the position of the main “Large Peak”. It uses this information to provide a reliable and efficient method of sonde location.

Method

1. Insert the activated sonde into the pipeline. Push the sonde about 10 – 12 Feet (3-4m) into the pipe.
2. Switch on the vLoc3 series receiver and use long presses on the “return key” until the sonde screen appears.



11 Locating the Camera Sonde and Pushrod

3. Press the "f" key to select the sonde frequency being used.
4. Hold the locator vertically and stationary with the tip on the ground.
5. If the locator is within the range of the sonde the screen will appear similar to the one below with an arrow pointing in a particular and steady direction. The bar graphs either side of the screen are identical and give an indication of the signal strength. Use the + and – keys to alter the receiver gain to keep the signal within the limits of the bar graph.

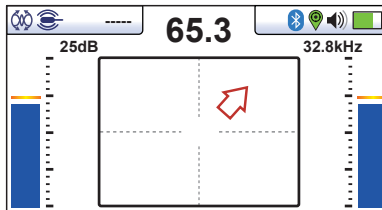

6. If the bar graph is not steady it will most likely be because the sonde is not within range. In this case hold the locator at approximately 45 degrees to the ground and rotate the locator around a full 360 degrees around you. Note the direction of strongest signal and walk toward it until the bar graph shows a steady signal. Now revert to step five above.
7. Walk slowly in the direction of the arrow.
8. A double circle will appear on the screen. This indicates the position of a null signal. Walk toward it and position it over the cross hairs of the screen. Now rotate the locator so that the arrow is pointing forward.

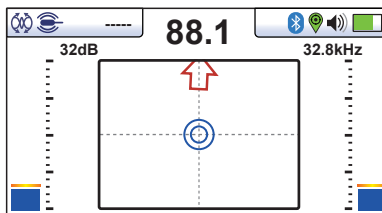

9. Keeping the null indicator on the vertical line, walk toward the arrow.
10. A Sonde icon will soon appear. Keeping the locator vertical, carry on walking toward the Sonde until it is positioned on the cross hairs. The locator is now directly over the Sonde. The arrow will flip forward and back as the position is crossed.

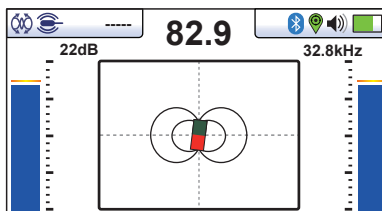

11. Note that when directly over the Sonde, it may be necessary to confirm the position of the Sonde, left to right. To do this move the locator left to right to identify the position of the strongest signal as indicated on the bar graph. At this time the depth to the Sonde will be displayed at the top of the display.
12. Having pinpointed the position of the Sonde, it can now be pushed in to a new location and the process repeated. It is advisable to keep the survey intervals to short distances such as six feet (two meters) as this makes the process of locating easier.
13. Pressing the Information key allows access measurement data and to data logging capabilities.

11 Locating the Camera Sonde and Pushrod

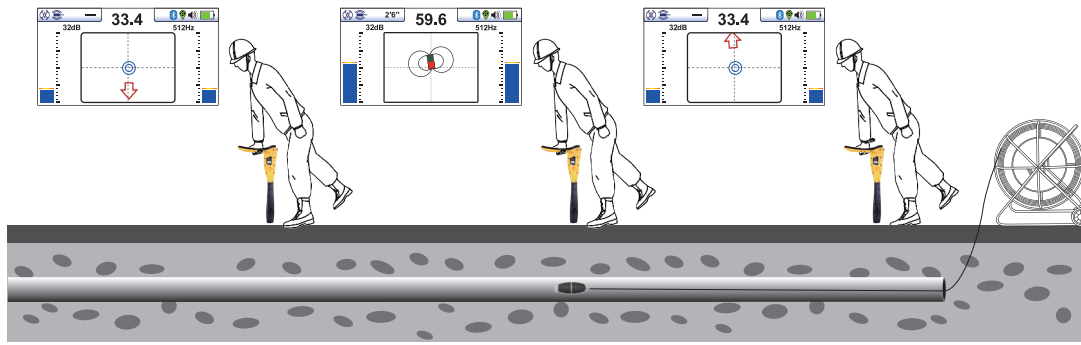

Overview

11.4 VM-540 Sonde and Camera Locator



VM-540 Receiver Display

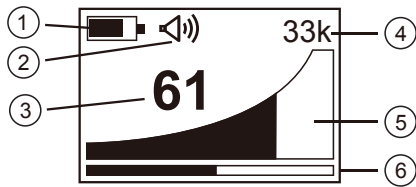

1	Battery Level Indicator
2	Speaker Volume Indicator
3	Signal Strength Percentage
4	Selected Sonde Frequency
5	Signal Strength Indicator
6	Sensitivity Setting Indicator

VM-540 Receiver Controls

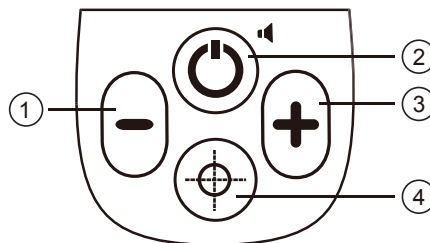

1	Reduce Sensitivity	Press this key to reduce the amount of signal from the sonde.
2	On/Off Control	Long press to switch on/off. Short press to change speaker volume.
3	Increase Sensitivity	Press this key to increase the amount of signal from the sonde.
4	Depth Measurement or Frequency Selection	A short press will calculate the depth to a sonde. Press and hold to enter frequency select menu, short press to exit the menu.

Power Mode Operation

Switch on the receiver by pressing the **On/Off** pushbutton. Allow the unit a few seconds to switch on.

The frequency selected is shown on the display. If this is not the desired locate frequency (i.e. 50 or 60 Hz) change as instructed below.

Changing the Locate Frequency

Press and hold the **depth measurement/frequency selection** pushbutton until the frequency menu is entered. The display will show the present frequency selected in large numbers in the centre of the screen. Use the “+” or “-” pushbuttons to select the desired frequency. Press the **depth measurement/frequency selection** pushbutton to re-enter the locate screen.

Locating a Cable in the Power (50/60 Hz) Mode

Hold the locator vertically in the area that is required to be searched. Adjust the sensitivity of the locator by pressing the “+” or “-” pushbuttons to keep the signal on scale. Hold the locator in front of you in the orientation shown below.

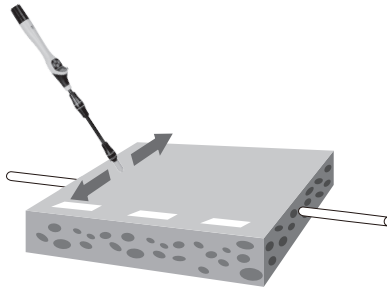

Sweep the locator left to right along the suspected route of the cable. As the locator approaches the cable the meter reading will increase. Pinpoint the position by detecting the largest signal.

To confirm the direction of the cable, rotate the locator until the largest signal is detected. The direction of the cable is then straight ahead, pointing forward, away from the display.

Continue to locate the cable along the route. Depth measurements are not possible in the power (50/60 Hz) mode, if pressed by accident it will show N/A.

WARNING

The power mode is used to detect signals radiating from cables or services that are carrying a 50 or 60 Hz load. It is possible for a cable to be live but not carry a load.



In this case there may not be a signal to be detected.

Similarly, if a cable is exactly balanced the resulting signal radiating from the cable may be zero and therefore not detectable.

Do not use the VM-540 to identify cables if they are live. Always dig with caution.

Sonde Locating with the VM-540

Power up the Sonde and securely attach it to a suitable duct rod for the application.

Insert the Sonde and position it to the pipe or duct leaving it still visible.

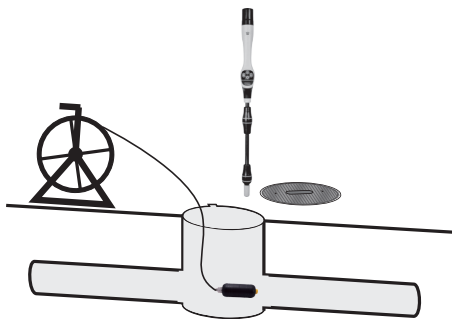

Hold the locator above the Sonde at ground level. Adjust the sensitivity of the locator by pressing the “+” or “-” pushbuttons to keep the signal on scale. Rotate the receiver until the maximum signal is detected.

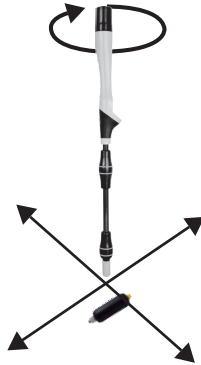

NOTE:

Moving the locator further left and right will result in detecting smaller “ghost” signals either side of the main one, this is normal. Always be sure to locate all three peaks when locating the position of the Sonde as the ghost signals are not directly over the Sonde. The largest one is the true position.

Moving back and forth across the Sonde will not detect ghost signals.

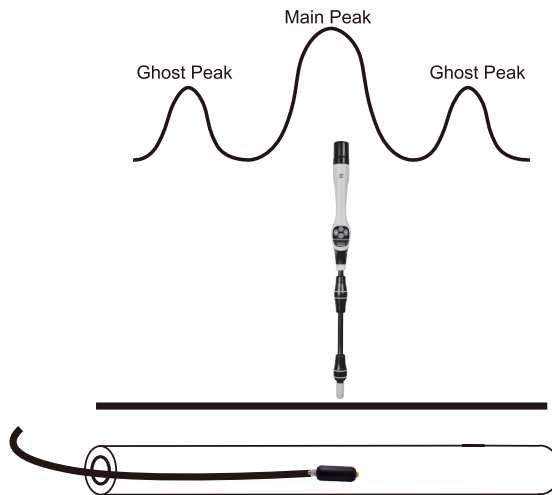

Now push the Sonde a few feet into the pipe. Stop and re-locate the Sonde. The direction of the Sonde can be confirmed by holding the locator vertically and rotating it on its axis until the largest signal is detected. The Sonde will then be pointing at right angles to the display.

Continue pushing a short distance and relocating as the Sonde is pushed into the pipe. Do not be tempted to push the rod too far into the pipe without locating the Sonde as this will make finding the Sonde more difficult.

Depth Measurement

To take a depth measurement first pinpoint the position and direction as previously described, pinpointing left/right, forward/back and also rotating on its axis. Hold the locator vertically over the position of maximum signal. Now press the “target” pushbutton. There will be a short delay before a depth estimate will be displayed.

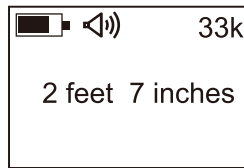

NOTE

The depth measurement is an approximation. Depth indications can be affected by field distortion caused by interference from in-band signals or metal structures such as rebar. An aid to determining if the depth is correct is to repeat a depth measurement with the locator a known distance (for example 1 foot above the ground) and to note if the depth has increased by this amount. If it is different from what is expected treat the data as suspect.





IMPORTANT

Always "Call Before You Dig" and follow your own company's safety practices.

Always follow local, state and national regulations.



12. Accessories

12.1 Skid Range

Model	Description & Diameter	Picture	Available for cameras
D18-MX Standard	Standard Skid comes with the camera		D18-MX
D26-MX Standard	Standard Skid comes with the camera		D26-MX



Visit our website at www.vivax-metrotech.com or contact your local distributor to view the full range of accessory skids available.

12.2 Accessories

Description	Picture
<p>Insertion Sleeve Use the insert sleeve to help prevent scraping of the pushrod at the access point.</p>	
<p>Drip Bags, Use drip bags when working indoors to help prevent water and debris from falling off the pushrod onto a floor or carpet.</p>	

Contact a local Vivax-Metrotech distributor or local office for ordering information, applications, compatibility and pricing.

12.3 Camera and Sonde Locators

Description	Picture
<p>vLoc3-Cam Sonde Locator - comes standard with sonde/camera frequencies of 512Hz, 640Hz, 8.192kHz, 9.82kHz, 33kHz, and 83kHz. The receiver is equipped with two "Passive" locate modes of Power and Radio which will detect the presence of power lines, CATV, telephone and some metallic pipes which radiate 50/60 Hz from nearby or overhead power lines and induced VLF signal from nearby broadcast towers. Push-button depth displays your depth of cover in feet and inches.</p>	
<p>VM-540 Sonde Locator - locates any cameras, sondes, pushrod or crawler camera systems with matching frequencies. The VM-540 Sonde Locator comes with a 50/60Hz power mode and three sonde frequencies of 33 kHz, 512 Hz, and 640 Hz.</p>	

Contact a local Vivax-Metrotech distributor or local office for ordering information, applications, compatibility and pricing.

13. Troubleshooting

Problem: No power, unit will not turn on:

Check:

1. Check to see that the fuse is installed, blown or damaged in any way. If the fuse is not installed then the unit will not charge your battery.
2. Try using mains current and not battery to turn on the unit. If the unit does power on with mains current then your battery is not charged and that may be the reason it will not power on.
3. While the unit is charging see if the battery icon on the front panel is glowing red, or if turned on that you see a lightning bolt inside the battery icon on the bottom right corner of the LCD.

Problem: Not recording:

Check:

1. Check the battery level. When the battery is low the unit may not have enough power to record.
2. Check available disk space on the USB drive.

Problem: Sonde not working:

Check:

1. Check the control module's battery level. When the battery is low the sonde may not operate.
2. Check that the sonde frequency in the control module matches that of the sonde locator.

Problem: Distance counter not accurate:

Check:

In the menu settings for reels check:

1. Check if the distance counter setting is set to Meters or Feet.
2. Check that the friction brake is not slowing down the cage so much that it jerks in and out.

Problem: Interference or noise on LCD:

Check:

The Sonde in some circumstances can cause interference on the video being viewed or recorded. It is recommended that the Sonde is turned off unless it is actually being used for location. This also saves power.

Problem: USB or SD device not recognized:

Check:

Make sure the media device is working and not corrupt.

Try formatting the device in the control module.

Read the section in this manual "File Format of SD Cards and USB Drives"

Problem: No audio being heard on recorded video:

Check:

1. Check that volume is turned up during playback. Use key function Ctrl - to lower volume and Ctrl + to raise the volume.
2. Assure that the red microphone icon was showing on the status bar and that the microphone button was illuminated during the audio recording.
3. Assure that the audio comments were directed towards the internal microphone between one and three feet from the internal microphone.

Problem: Dark or hard to view display:

Check:

1. Check that the cameras LED lights are turned on.
2. Press the Display key on the main on-screen menu and check the brightness and backlight settings.

